

# REPRO-5 USER GUIDE

The screenshot displays the REPRO-5 software interface, organized into several functional sections:

- Top Bar:** Includes the u-he logo, MIDI channel (B), voices (8), and various utility buttons like SYNTH, TWEAKS, PRESETS, VIEW, UNDO, REDO, SAVE, MC, HQ, TUNE, and OUTPUT.
- Parameters:**
  - VOICE MOD:** Controls for FILTER, FREQ A, PW A, DESTINATION, and SOURCE AMOUNT.
  - OSCILLATOR A:** Controls for FREQ, SHAPE, OCTAVE, and PULSE WIDTH.
  - OSCILLATOR B:** Controls for FREQ, SHAPE, OCTAVE, and PULSE WIDTH.
  - MATRIX:** A table for mapping Mod Wheel and LFO to various parameters like Voice Index, LFO, Frequency, SOURCE, and DESTINATION.
  - WHEEL MOD:** Controls for FREQ A, FREQ B, PW A, PW B, DESTINATION, and SOURCE MIX.
  - LFO:** Controls for RATE and SHAPE.
  - HOST SYNC:** A checkbox for synchronization.
  - MIXER:** Controls for OSC A, OSC B, UNISON, and VOICE DETUNE.
  - FILTER:** Controls for CUTOFF, RESONANCE, ENVELOPE AMOUNT, and KEYBOARD AMOUNT.
  - AMPLIFIER:** Controls for ATTACK, DECAY, SUSTAIN, and RELEASE.
- Keyboard:** A digital piano keyboard is shown on the right side of the interface.
- Bottom Bar:** Includes buttons for PB, MOD, EFFECTS, and KEYS.

**ההמחאה**  
**חברה סונטם**

## REPRO-5 SYNTHESIZER USER GUIDE

by u-he / Heckmann Audio

Revision 1.1.2

S/N 1000 up

User Guide No. HA1000D

Date: 22. July 2021

### About Repro-5

First we released Repro-1, a faithful component-level model of what was perhaps the most powerful-sounding monophonic keyboard ever built. Repro-1 proved to be a very successful product! It seemed that people liked Repro-1 so much, they wanted more... would we please consider making it polyphonic?

After umming and ahing about the idea, we decided to give it our best. A few cuts were inevitable (for instance in Repro-1 oscillator B can modulate its own pulse width, which we gladly dropped from Repro-5).

We soon realized what was happening to our new baby: It was looking more and more like its true father, a famous **5-voice polyphonic** synthesizer from the same company born in 1978. We were aware that a polyphonic Repro-1 would never grow up to be a 100% clone of that synth, but with basically the same sound plus a few tweaks, 99% will do nicely thank you!

So here it is: All the lovable quirks of that classic polyphonic synthesizer, plus several additions including more voices (max. 8) and a row of very cute stomp-boxes. We hope that Repro-5 will quickly become your favourite “classic analogue polysynth”.

### Product Names

The polyphonic version was dubbed *Repro-5* for obvious reasons, but we were presented with another conundrum: Repro-5 had to reside within the file layout we had already set up for Repro-1, and we couldn't rename everything *Repro* internally without breaking stuff for our existing Repro-1 customers. So Repro-5 uses resources within Repro-1 folders. Ignore!

So: The product bundle called **Repro** contains two plug-ins – a monosynth called **Repro-1** and a polysynth called **Repro-5**. The installer for both is still called **Repro-1**. Alles klar?

- *Urs and the team*

<b>1</b>	<b>INTRODUCTION</b>	<b>4</b>
1-1	INSTALLATION.....	4
1-2	RESOURCES .....	4
1-3	KNOBS AND SWITCHES.....	5
1-4	THE CONTROL BAR .....	6
1-5	KEYBOARD and WHEELS .....	7
<b>2</b>	<b>PRESET BROWSER</b>	<b>8</b>
2-1	DIRECTORY PANEL.....	9
2-2	PRESETS PANEL .....	11
2-3	INTERNAL DRAG & DROP .....	12
2-4	EXTERNAL DRAG & DROP .....	12
2-5	INSTALLING SOUNDSETS .....	13
2-6	TAGGING .....	14
2-7	SEARCH BY TAGS .....	15
2-8	SEARCH BY TEXT .....	17
2-9	SMART FOLDERS .....	19
<b>3</b>	<b>SYNTH</b>	<b>20</b>
3-1	OSCILLATOR A .....	20
3-2	OSCILLATOR B .....	21
3-3	MIXER.....	22
3-4	UNISON, GLIDE & VOICE DETUNE .....	22
3-5	FILTER .....	22
3-6	AMPLIFIER.....	24
3-7	VOICE MOD .....	25
3-8	LFO .....	26
3-9	WHEEL MOD .....	26
3-10	MATRIX.....	28
<b>4</b>	<b>TWEAKS</b>	<b>31</b>
4-1	JUMPERS.....	31
4-2	SELECTORS .....	32
4-3	VOICE PANNING .....	33
<b>5</b>	<b>EFFECTS</b>	<b>34</b>
5-1	DISTORTION .....	34
5-2	FX CHAIN .....	35
5-3	VELVET tape saturation.....	36
5-4	LYREBIRD delay.....	37
5-5	RESQ resonator / equalizer .....	38
5-6	DRENCH reverb .....	39
5-7	SONIC CONDITIONER.....	40
<b>6</b>	<b>CONFIGURATION</b>	<b>41</b>
6-1	ABOUT MIDI CC .....	41
6-2	MIDI LEARN .....	41
6-3	MIDI TABLE .....	42
6-4	PREFERENCES .....	43
<b>7</b>	<b>NKS</b>	<b>45</b>
<b>8</b>	<b>Troubleshooting</b>	<b>46</b>

# 1 INTRODUCTION

## 1-1 INSTALLATION

The following procedure installs both **Repro-1** and **Repro-5** on your hard disk

Go to the [Repro](#) web page and download the latest installer for Mac or PC. Unzip the file, open the **Repro-1** folder, start the installer application and follow instructions.

The only demo restriction is a mild crackling at irregular intervals after about two minutes use. The crackles disappear after you have purchased a license and entered the serial number. For more information, please refer to the *ReadMe* file included with the installer. By default, **Repro-5** uses the following directories on your hard disk:

### Windows

Presets (Local)	C:\Users\*YOU*\Documents\u-he\Repro-1.data\Presets\Repro-5\
Presets (User)	C:\Users\*YOU*\Documents\u-he\Repro-1.data\UserPresets\Repro-5\
Preferences	C:\Users\*YOU*\Documents\u-he\Repro-1.data\Support\ (*.txt files)
Alternative skins	C:\Users\*YOU*\Documents\u-he\Repro-1.data\Support\Themes\

Paths containing non-standard characters are not supported. If a previous installation into e.g. the *VstPlugins* folder didn't cause file permissions problems, you can safely reinstall there.

### macOS

Presets (Local)	MacHD/Library/Audio/Presets/u-he/Repro-5/
Presets (User)	MacHD/Users/*YOU*/Library/Audio/Presets/u-he/Repro-5/
Preferences	MacHD/Users/*YOU*/Library/Application Support/u-he/com.u-he.Repro-5...
Alternative skins	MacHD/Library/Application Support/u-he/Themes/ (skin folder)
Other Resources	MacHD/Library/Application Support/u-he/Repro-1/

The “Repro-1” in the above paths is not a copy/paste error. See [Product Names](#) on page 2!

To uninstall **Repro**, delete the plugin files and these folders.

**Important:** Realtime malware scanners (e.g. Windows Defender) allowed to scan u-he plugin resources will slow down the browser considerably, depending on the number of presets. Please add the **Repro-1.data** folder to the scanner's exceptions list (you can rest assured that we haven't put any executable files in there). Mac owners using a malware scanner should add the above /u-he/ resource directories to the exceptions list.

## 1-2 RESOURCES

### u-he online

For downloads, news articles and support, go to the [u-he website](#)

For heated debates about u-he products, go to the [u-he forum](#)

For friendship and informal news updates, go to [u-he facebook page](#)

For video tutorials and more, go to the [u-he youtube channel](#)

For our soundsets and bundles, go to [u-he soundsets](#)

For 3rd party presets, go to [PatchLib](#)

## u-he team 2021 (Q2)

Urs Heckmann (boss, concepts, big code)  
Jayney Klimek (office management)  
Howard Scarr (user guides, presets, grump)  
Rob Clifton-Harvey (IT admin, backend development)  
Sebastian Greger (graphic design)  
Jan Storm (framework, code)  
Alexandre Bique (all things Linux)  
Oddvar Manlig (business development)  
Viktor Weimer (support, presets)  
Thomas Binek (QA, bug-hunting, presets)  
Henna Gramentz (office supervision, support)  
Frank Hoffmann (framework, browser)  
Alf Klimek (rock-star, studio, voiceovers)  
Sebastian Hübert (media, synthwave)  
David Schornsheim (more code)  
Stephan Eckes (yet more code)  
Luca Christakopoulos (communication design)

Special thanks to:

**William Rodewald** for hardware analysis and code  
**John Bowen** for some history-making presets  
**Brian Rzycki** for maintaining the original patch library

## 1-3 KNOBS AND SWITCHES

The knobs respond to vertical click & drag as well as to mouse wheel movement (no clicks required!). You can **fine tune** most parameters, often at a resolution of 0.01, by holding down SHIFT before clicking on the knob. How switches react depends on a global preference called *Switch Behaviour* – see the [Configuration](#) chapter.

The name and value of the control currently being edited appears in the **data display**, which you will find in the middle of the control bar (see below).

**Parameter Locking:** To prevent a value from changing when you switch presets, use the *Lock* function – right-click on any control and select the last entry in the menu. Don't forget to unlock afterwards, otherwise presets will sound "wrong".

**Entering values:** The value of the most recently used control can be set by entering numbers on your computer keyboard. Switches take integer indices e.g. you can set *Clock* to 1/16 by entering '19'. Please note that hosts respond differently to keyboard strokes while a plug-in has the focus – you might have to set an option to allow this feature. If in doubt, please refer to the documentation of your host app.

## 1-4 THE CONTROL BAR

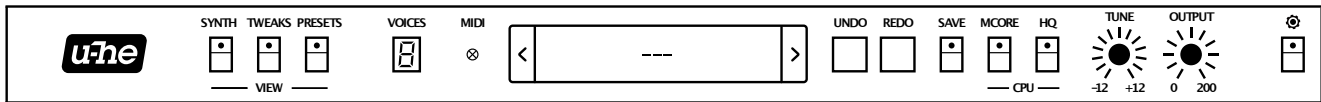

**u-he Badge:** Click on the badge for direct access to our website, to this user guide and other Repr5 documents, to our user support forum at KVR or to our social network pages. At the bottom of the menu is the entry *Install Soundset...* Unless you are running Linux, you probably won't need this – see [2-4 INSTALLING SOUNDSETS](#).

**SYNTH, TWEAKS, PRESETS:** These buttons switch between Repr5's three basic views. To ensure that each new instance will open in the current view, right-click anywhere within the row of buttons and select *set current as default*.

**MIDI activity:** An indicator which flashes whenever MIDI data is being received.

**Data Display:** Normally shows the name of the preset. Clicking in the middle of the display lets you select any preset from the current folder. While editing, the name and value of the parameter is displayed, and the preset name reappears after a few seconds.

**UNDO / REDO buttons:** Use these to fix any mistakes. Although the number of steps in the undo-buffer is limited, you can even undo a change of preset.

**PRESET buttons:** These step backwards and forwards through all Repr5 presets.

**SAVE button:** Stores the preset into either the currently selected folder or the 'User' folder, depending on the *Save Presets To* preference (see chapter 6). To select a different folder, click on PRESETS and navigate in the directory. Then click on [SAVE], give your preset a suitable name and enter any details you would like to appear in the PRESET INFO area of the browser. Note: Please avoid using these characters while naming folders/presets: (\ / ? % \* : " > < =).

Right-clicking on [SAVE] opens a menu with a choice of file formats. The recommended *h2p* is our cross-platform format (editable text), while *h2p extended* includes extra readable information. The *native* option is the standard format of your system (.fxp for VST and AAX, .aupreset for Audio Units). An *nksf* option also appears in the VST2 version (see [chapter 7](#)).

**MCORE (multicore) button:** All played voices are distributed between multiple CPU threads so that more can be played simultaneously. This works well on recent processors (e.g. i5 and i7) but please note that performance can actually be reduced if your CPU is older. Some hosts offer their own multicore support, and this can also lead to poorer performance for Repr5. In such cases, please switch one of them off. See [Multicore Threads](#) in the Preferences section.

**HQ button:** The global *High Quality* option should only be necessary for extreme FM sounds or extreme pitches. Circuit-level modeling requires plenty of CPU anyway, and there's no point in doubling that requirement for little or no difference in the sound. Consider carefully!

**VOICES:** The maximum number of voices played before note-stealing occurs. Also the number of stacked voices when UNISON is switched on.

**TUNE:** Tunes the preset within a range of +/- 12 semitones. For fine tuning, hold down a SHIFT key on your computer keyboard while adjusting.

**OUTPUT:** A final volume control, after all amplifiers and effects. Normally set to 12 o'clock i.e. 100%, the volume can be boosted up to 200% if necessary.

**Configuration button:** A click on the button below the cogwheel icon opens the configuration pages, which contain MIDI control options and various global settings. See [chapter 6](#).

## 1-5 KEYBOARD and WHEELS

The **FX** button at the bottom left toggles between the effects and the keyboard view:

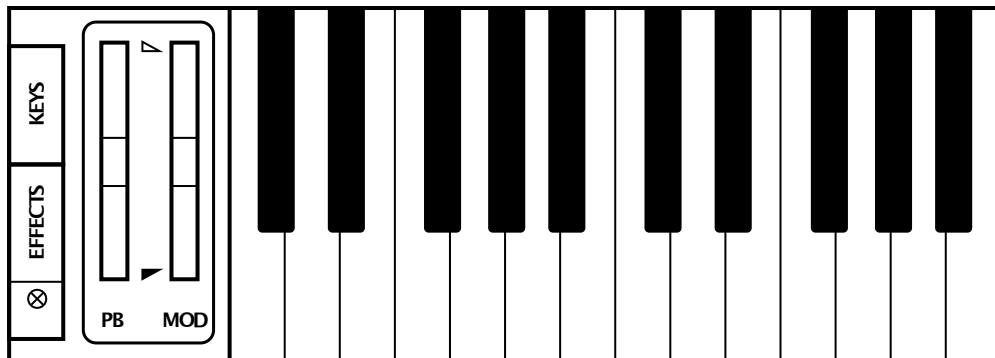

**Keyboard:** Most of this panel is taken up by a 5-octave keyboard — the same range as the original synth. You can click the keys to fire off notes. Double-clicking on a key will sustain the note until you click on another.

Immediately to the left of the keyboard are two ‘left-hand controls’...

**PITCH BENDER (PB):** Centre-sprung control of overall pitch. The ranges (down and up, from 0 to 48 semitones) can be set in the TWEAKS page. Repro-5’s pitch wheel mirrors incoming MIDI pitchbend data, but can also be moved with the mouse.

**MODULATION WHEEL (MOD):** Mirrors incoming MIDI CC#01 (modulation wheel) but can also be moved with the mouse. Not centre-sprung but positive-only, 0.00 to 100.00.

**WHEEL MOD LIMITS:** The small **triangles** between the two wheels are used to set upper and lower limits of wheel modulation (see WHEEL MOD). For instance, if you want a certain minimum amount of LFO/noise modulation when the wheel is all the way down, move the red triangle up a little. Similarly, to restrict the vibrato range i.e. limit the maximum amount, pull the white triangle down. To move both of them together, roll the mouse wheel.

Note: These limits do not affect the depth of wheel modulation defined in the MATRIX.

### Vibrato via modulation wheel

- In the WHEEL MOD panel, activate the **FREQ** buttons for both oscillators
- Set the WHEEL MOD LIMITS to 0.00 and about 10.00
- If you need a certain minimum vibrato when the wheel is at its lowest position, bring the lower (red) triangle up very slightly.

## 2 PRESET BROWSER

In the control bar, click on the PRESETS tab. You should see something like this:

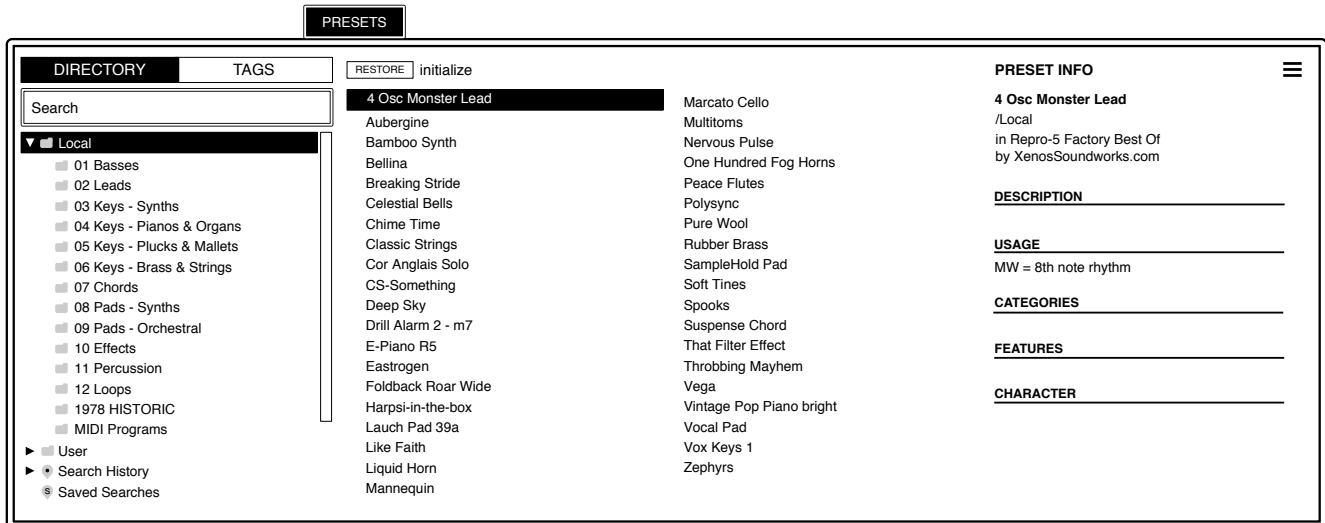

Folders appear on the left (drag the scrollbar to see more), presets appear in the centre and information about the currently active preset appears on the right. If you can't see any presets, at all, click on *Local* then on *01 Basses* (for instance). If you don't see a PRESET INFO panel, click on the [≡] button in the top right corner and activate *Show Preset Info*.

Note: The Local root directory contains a representative selection of presets.

To load a preset, click on its name. Immediately after selecting a preset you can step through all the others using your computer's cursor keys.

### Default, initialize

Whenever Repro-5 is started it checks whether the Local root contains a preset called *default*. If this file exists, it is loaded instead of the demo sound.

If you want Repro-5 to start with a simple template instead of the default preset, right-click on the data display and select *init* (initialize). Check that the 'Local' root directory is currently open then [SAVE] your preset under the name *default*.

Note that *default* will not appear in the browser. If a fresh instance of Repro-5 is not loading your new *default*, it probably landed in 'User' instead, in which case you should change the *Save Presets To* setting (in Configuration/Preferences) and repeat the above.

### More Sounds

Soundsets we sell online are in the *.uhe-soundset* format (see [2-4 INSTALLING SOUNDSETS](#)). Many 3rd party sounds, commercial as well as free, are also available via [Patchlib](#).



## 2-1 DIRECTORY PANEL

If you don't see this panel in Repro-5's PRESETS browser, click on DIRECTORY.

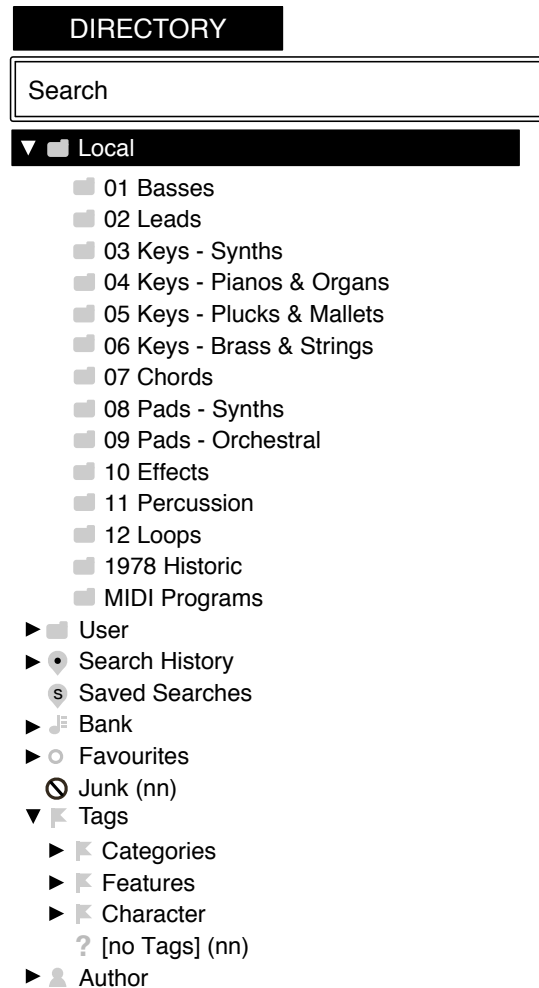

### The 'Local' folder

Repro-5's factory presets are sorted into folders 01 to 10. We recommend that you do not add or remove any presets there, but save all your creations to 'User' (see below).

Named after the year Repro-5's hardware ancestor first appeared, the **1978 Historic** folder contains the original 40 presets, meticulously recreated using several different sources.

'Local' also contains a special folder called '**MIDI Programs**' which is normally empty. When the first instance of Repro-5 starts, up to 128 presets from that folder are loaded into memory so they can be selected via *MIDI Program Change* message. It is a good idea to call those presets e.g. '000 rest-of-name' to '127 rest-of-name', as they are accessed in alphabetical order.

But that's not all: the 'MIDI Programs' folder can contain up to 127 sub-folders, switched via *MIDI Bank Select* messages (CC#0). Send *Bank Select* first, then *Program Change*. 'MIDI Programs' is bank 0, sub-folders are addressed in alphabetical order starting with bank 1.

When Repro-5 receives a program change, it will display the bank and program numbers to the left of the preset name e.g. "0:0" for the first preset in the first bank. In certain hosts e.g. Ableton Live, however, the first bank / preset is designated "1" instead of the correct "0".

To avoid another possible source of confusion, make sure that there are no junked presets in the MIDI Programs folder. All files there are indexed, whether they are visible or not.

### IMPORTANT

‘MIDI Programs’ cannot be added, removed or renamed on the fly – any changes to that directory will only be updated after the host application is restarted.

## The ‘User’ folder

The best address for all your creations! You can either select *User* immediately before saving the preset, or set a global preference which ensures that it will **always** be saved to this folder – see the *Save Presets To* preference (chapter 6).

Tip: It’s worth finding out where the *User* folder resides on your computer, especially if you want to manually install soundsets. Right-click on *User* and select *Open in Finder / Explorer*.

## Search History, Saved Searches, Favourites, Junk, Tags

These aren’t regular folders, but *smart folders*. See section [2-7](#).

## Directory context menu

Right-clicking on any folder within *Local* or *User* will open this menu:

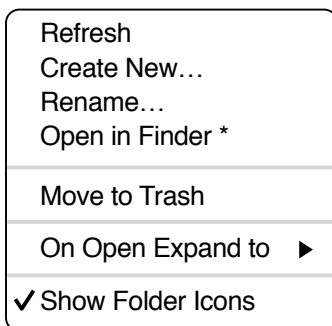

**Refresh:** Update the contents of the browser. Required for Windows users.

**Create New...** Insert an empty subfolder.

**Rename...** Edit the folder name.

**Open in Finder / Explorer:** Open a system window for the currently selected folder. If you hold down an option key (Mac) or ctrl key (Windows), the entry will change to *Show in Finder / Explorer* and the folder will be highlighted instead of opened.

**On Open Expand to:** This setting determines how deeply the browser will open subdirectories whenever the GUI is opened again or the *Refresh* function is called. The first option (*none*) collapses all folders, while the final option (*all levels*) reveals all nested folders.

**Show Folder Icons...** Deselect this option if you find the folder icons distracting. The Junk icon is always visible.

## 2-2 PRESETS PANEL

The central, unlabelled area of the browser is where you click to load presets...

### Presets context menu

Right-click to open a menu containing functions you can apply to individual presets.

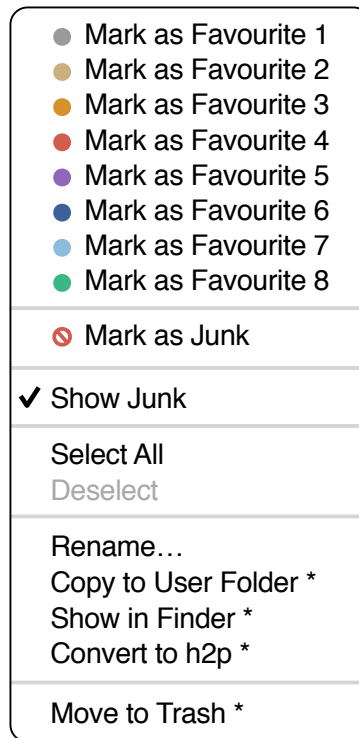

**Mark as Favourite:** Choose just one of eight differently coloured dots. To remove the dot again, right-click on the preset(s) and select *unmark as favourite*.

**Mark as Junk / Show junk:** Instead of deleting unloved presets, mark them as 'junk' so that they disappear from the browser. Activate **Show Junk** to display junked files instead, and mark them with a STOP symbol.

**Select All / Deselect:** See *Multiple Selection* on the next page.

**Rename...** You can change preset names with this function. Note that only the most recently selected preset can be renamed i.e. you can't rename multiple files at once.

**Copy to User Folder / Duplicate:** This entry depends on the status of Save Presets To as well as on the location of the source preset(s) – whether they are in the Local or the User folder. Selected presets are copied with a number appended to the name, which increments (just like the Auto Versioning option) so that no preset can be overwritten by mistake.

**Show in Finder / Explorer:** Opens a system window for the right-clicked file. In smart folders only, holding down an option key (Mac) or ctrl key (Windows) replaces this entry with Show in Browser, which shows the currently selected file in its original location within xx's browser.

**Convert to native / h2p / h2p extended:** Converts the selected preset(s) into the format previously selected via right-click on the [SAVE] button.

**Move to Trash / Recycle Bin:** Moves the selected preset(s) to the system trash.

## [RESTORE] button

You can try out any number of presets without losing track of the one that was loaded immediately before you opened the browser. Clicking on the [RESTORE] button loads that preset and opens the enclosing folder.

## Scan / Ready

In the top right of the presets panel is a dark rectangle normally labelled 'ready'. Whenever you use the refresh function (see the Directory context menu on the previous page), this turns into a progress indicator showing the preset database being refreshed.

## Multiple selection

A block of presets can be selected via shift+click, and individual presets can be added via cmd-click (Mac) / alt+click (Windows). Presets can be moved to a different folder via drag & drop. To deselect, click on an unselected preset or choose *Deselect* from the context menu.

## PRESET INFO

The area to the right displays information about the selected preset. If you can't see it, click on the triple bar [≡] button in the top right corner and tick *Show Preset Info*. Another option in the same menu lets you show or hide the tags only.

## 2-3 INTERNAL DRAG & DROP

You can drag and drop single or multiple files from the preset panel onto any folders in the directory panel. Files dragged onto regular folders will be moved unless you hold an **option** key (macOS) or **ctrl** key (Windows), in which case they will be copied instead. Files dropped onto smart folders will adopt the attribute of that folder: For instance, you can set the Author or Favourite status of several presets at once. See also [tagging using the Tags subfolders](#).

## 2-4 EXTERNAL DRAG & DROP

To manage your preset library externally you can drag presets and folders between Repro-5's browser and your desktop (or any system window).

On the Mac most Finder operations will automatically update the browser. Updating might not be immediate when using multiple formats or multiple host applications, but all it usually takes is a click on the GUI or directory tree (sets focus to the clicked instance of Repro-5). On Windows systems, a manual *Refresh* (see [Directory context menu](#)) will be required before changes to the contents of the browser appear.

Another little helper: If you drag a Repro-5 preset from e.g. your desktop and drop it onto the Data Display, that preset will be loaded (but not automatically saved).

## Exporting smart folders

Drag any smart folder onto the desktop to create a new folder containing those presets. Drag an entry from your Search History, or the Category 'FX', the Favourites or one of the Authors.

## Exporting favourite / junk status

You can export Favourite status, all at once or individually: Shift+click and drag the 'Favourites' folder onto the desktop to create a file called *Favourites.uhe-fav*. Similarly for sub-folders: If you shift+click and drag e.g. 'Favourites 5', this will create a file called *Favourite 5.uhe-fav*. The same method works for Junk status, creating a file called *Junk.uhe-fav*. Such files can be imported into Repr0-5's browser on a different computer (for instance), via drag & drop onto or anywhere within the Favourites folder, or to the Junk folder.

Note that importing .uhe-fav files from another computer will only work 100% correctly if all preset names and locations are identical on both computers!

## 2-5 INSTALLING SOUNDSETS

All soundsets we distribute ourselves will (eventually) be available in *.uhe-soundset* format. Third parties are also encouraged to use this package format for their own commercial soundsets – for details please contact our support team.

### Standard Method

To install, drag & drop the *.uhe-soundset* file into Repr0-5 – anywhere will work. The soundset should appear in the 'User' folder. If a soundset with the same name already exists there, any modified files will be backed up and the location of the backup file will be displayed.

### Alternative Method

Soundsets in *.uhe-soundset* format can be installed by clicking on the u-he badge and selecting *Install Soundset...* from the menu. This option is especially useful for Linux, as the browser version for that platform does not support drag & drop.

### Regular Folders

Folders containing Hive presets can be manually copied or moved into the 'User' folder. You might have to refresh the browser (see [Directory context menu](#)) before they appear there. A refresh is generally necessary in Windows but not in macOS.

Note: As *.uhe-soundset* files are basically ZIP-compressed folders, you can rename them i.e. replace the long file extension with '.zip' then extract everything in the usual way.

## 2-6 TAGGING

“Tags” are elements of metadata (information) you can add to presets so that they can be found according to certain attributes. See the image below.

**IMPORTANT:** Clicking on [SAVE] isn’t required, as tags are updated automatically. This makes editing tags much easier overall, but also means that you should only add tags **after saving your preset**. Why? Because if you change the tags while creating a new version of something, you would also be changing the tags in the original preset.

To set tags, you have a choice of three different methods:

### Standard method: Using the tagging window

Right-click on the [SAVE] button and select *Tag this Patch*:

#### CATEGORY

Bass
<b>Pads</b>
Leads
Keys
FX
Drums
Seq+Arp
Other

Airy
Analogue
Brass
Dist+LoFi
Drones
<b>Evolving</b>
Organs
Rhythmic
Soundscape
Strings
Synth
Vocal
Winds

#### FEATURES

Mono	Soft Attack
<b>Poly</b>	Slow Release
Chord	Glide
BPM	
OscSync	
CrossMod	
Dry	
Modulated	
Percussive	

#### CHARACTER

Bright	Dark
Constant	Moving
Clean	Dirty
Soft	Aggressive
<b>Phat</b>	Thin
Natural	Synthetic
Modern	<b>Vintage</b>

CATEGORIES describe a preset by analogy to instrument types or classic synth genres. Each one has its own set of subcategories. FEATURES are technical classifications, and CHARACTER tags are pairs of opposites from which you can choose only one.

### Alternative 1: Using the PRESET INFO

In the PRESET INFO panel, right-click on CATEGORIES, FEATURES or CHARACTER and select or unselect tags from the menu. Note: This method only works for individual presets. If you right-click on an existing tag, the first option in the menu becomes *remove tag 'xx'*.

The function *create Search from Tags* searches for presets with ALL the same tags.

### Alternative 2: Using the Tags subfolders

You can drag & drop presets onto *Tags* smart folders e.g. *Tags/Categories/Keys/Bells/*. To remove all tags from one or more presets, drag them onto the *[no Tags]* smart folder

## 2-7 SEARCH BY TAGS

Click on the large TAGS tab to open this view. The buttons in this panel let you set up search criteria according to tags with just a few clicks:

**TAGS**

Search

**CATEGORIES** ^

Bass Pads Leads Keys FX Drums Seq+Arp Other

**FEATURES** ^

Mono Poly Chord BPM OscSync CrossMod Dry

Modulated Percussive Soft Attack Slow Release Glide

**CHARACTER** ^

Bright Dark Constant Moving Clean Dirty

Soft Aggressive Phat Thin Natural Synthetic

Modern Vintage

**FAVOURITES** ^

1 2 3 4 5 6 7 8

There are four sets of buttons. The first three correspond to the tags in the tagging window (see the previous page), and the bottom row lets you search any 'Favourites'. Click the [^] button on the right to collapse any of these tag types.

### CATEGORIES and SUBCATEGORIES

Here are just a few bullet points to get you started. For this type of tag in particular, following a step-by-step tutorial is much easier than studying a full technical description. Try these:

- Each of the CATEGORIES has its own set of subcategories. Not selecting any subcategory here means “show me presets tagged **with any subcategory**”. Click on [Leads]...
- You can select multiple categories without specifying any subcategory if you hold **Cmd** (Mac) or **Ctrl** (Windows) while clicking on the category. Try that, click on [Keys].
- Selecting the subcategory with the same name as the category means “show me presets tagged **without a subcategory**”. You will not find any of these in the factory presets.
- Completed category+subcategory tags appear below the subcategories as buttons with 'off' switches [X] so you can add other main categories by simply clicking on them.

## Practical tutorial

- Click on the **DIRECTORY** tab, right-click on the *Search History* smart folder and select *clear*. Double-click on *Local/02 Leads* to restrict the scope of the search to that particular folder. The selected path */Local/02 Leads* appears below the Search field instead of preset folders.
- Click on the **TAGS** tab. In the CATEGORIES, select [Bass]. Subcategory buttons appear and the preset window is updated to list all presets in *02 Leads* that are also tagged as [Bass].
- Now click on [Pads]. The [Bass] category is switched off, and the preset window is updated to list all presets in *02 Leads* that are also tagged as any kind of [Pads]. As it happens, there is only one. Note that you still haven't specified a subcategory yet...
- Hold **Cmd** (Mac) or **Ctrl** (Win) and select the [Bass] category again. Although no longer outlined, the previously selected [Pads] remains highlighted and the list shows all presets in *02 Leads* that have either of those tags, disregarding any subcategories.
- Click on **DIRECTORY**: The text **#Bass:\* #Pads:\*** appears in the editable field as well as in the *Search History* smart folder (see section 2-7), which also shows the number of found presets. The colon separates the category from the subcategory, and the star (\*) means "any subcategory, even none".
- Click on the **TAGS** tab again. Select the [Leads] category **without** holding down Cmd/Ctrl this time... the [Bass] and [Pads] tags are removed from the search. Select [Sync Lead] as subcategory. The result is a list of all 15 presets in *02 Leads* that have the Leads:Sync Leads tag. Immediately below the subcategory options you will see the complete tag in the form **[Category:Subcategory|X]**.
- Let's get more hits by including another subcategory: Click on the [Distorted] subcategory. [Sync] remains selected, and the list of hits is updated to include presets which have **either** of those tags i.e. 40 in total. Click on [Sync Lead] again and the tag search will find only 30 presets – all those that are tagged as [Leads:Distorted].
- Click the [Bass] category. Below the subcategories, the [Leads:Distorted|X] switch remains in place because that tag is complete. Check out the category tags in PRESET INFO by clicking on several presets in turn: Each one will have either a Leads:Distorted tag or a Bass tag (disregarding subcategory) or both.
- Click on the **DIRECTORY** tab. The text **#Bass:\* #Leads:Distorted** appears in the search field as well as the *Search History* smart folder. If you are feeling adventurous, you can edit this and the results will be updated accordingly.
- To the left of the grey search path is an 'up' [^] symbol. Click on this to exit the current folder i.e. change the search path from */Local/02 Leads* to the */Local* root. The list of hits is immediately updated to 188 presets because the search now includes all of */Local*.
- Another click on [^] exits to the whole preset library i.e. */Local and /User*. Clicking on the [X] symbol to the right of the search path will exit immediately. Try that.

Repeat the above a few times if necessary – you'll soon get the hang of it!



## FEATURES, CHARACTER and FAVOURITES

These types of tags are much easier to explain. Unlike multiple Category tags, which **expand** the search, selecting these Tag types always **restrict** the search. Let's find all thin sounding presets with a slow release:

- If any CATEGORIES are still highlighted, click on them.
- Select FEATURES = [Slow Release] and CHARACTER = [Thin]. That's it.

### Summary:

In the DIRECTORY panel, specify a search path via double-click. In the TAGS panel, select category tags. Add others if required to extend the search, but remember to hold down **Cmd** (Mac) or **Ctrl** (Windows) if you want to retain category tags that don't specify a subcategory. Select Features, Character and/or Favourites tags to refine the search. Exit any search path by clicking on the [X] to the right.

## 2-8 SEARCH BY TEXT

The editable field immediately below the DIRECTORY and TAGS tabs lets you search for presets according to a string of characters i.e. text. The search normally looks into the preset name, the author, the DESCRIPTION and USAGE (see the PRESET INFO panel). It is not case-sensitive. Quotes are not required unless you need to include spaces.

If you want to restrict the search to a particular path e.g. *Local/02 Leads*, double click on the *02 Leads* folder. This path will appear below the Search field instead of the preset folders, and you will only see smart folders:

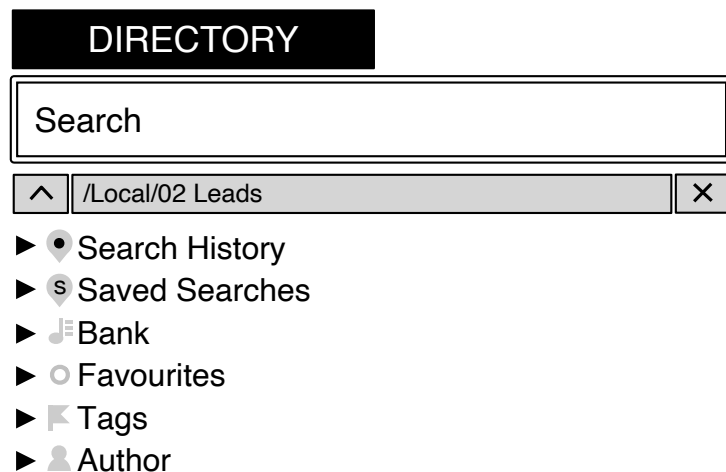

The [ ^ ] button to the left moves the search path up one level, in this case to */Local*. The [ X ] button to the right sets the search path to the default *Local* and *User* (i.e. all Repro-5 presets), and the preset folders become visible again. Alternatively, you can navigate directly to any higher level by right-clicking on the path.

Try a text search: Enter three or four letters then hit Return. For instance, *star* will find all files containing the text string *star* (e.g. *mustard* or *starters*). Entering "*star wars*" (with the quotes) would find e.g. *Battlestar Warship*, if such a string existed in the presets.

## Scope

You can limit the scope of the search to just the preset name or specific parts of PRESET INFO by using **name** (preset name), **author**, **desc** (description) or **use** (usage) followed by a colon. For instance, *author:the* finds all presets by sound designers whose author names contain 'the'. Similarly, *desc:space* will find all presets with the word *space* in the description.

## Logic

Important: The following logical operators can only be used between text elements.

AND requires that presets contain both words. It can be written explicitly if you prefer, but is not necessary. For example, *star AND wars* (or simply *star wars*) will find presets that contain both *star* and *wars*.

OR means that presets can contain just one of the words, or both. For example, *star OR wars* will find presets that contain *star* as well as presets that contain *wars*.

NOT excludes presets containing the word. To find all presets that contain *star* but don't contain *wars*, enter *star NOT wars*.

## Written Tags

Regular tags can also be entered into the search field if preceded with a '#'. For example, *name:"hs " #bass:\** will find all presets with "hs " in the name that are tagged as *Bass* with any or no subcategory. The colon separates category and subcategory, and the star (\*) means "any subcategory, even none". Between multiple tags of the same type is an implicit OR, while between different types is an implicit AND.

Note: In the current version of the browser, tags must appear after any text items!

## A few Example Searches

You could copy/paste these into Repro-5's search field and see what they find!

*desc:classic*

*author:ark*

*use:"at =" author:how*

*usage:"bc ="*

*"hs " OR xen #leads:\**

<i>tuc OR xs #pads:strings</i>	= all TUC and XS strings
<i>tuc OR NOT xs #pads:strings</i>	= all TUC and non-XS strings
<i>how OR NOT tuc #pads:strings</i>	= all HS and non-TUC strings

## 2-9 SMART FOLDERS

*Smart folders* do not contain files, they display the results of querying a database of all presets. The content is therefore dynamic i.e. it will change whenever the underlying data changes.

### Search History

Click on this folder to display the results of past searches (maximum 10). Whenever you need to make the results of a search more permanent, right-click and select *save Search...* The entry will be moved to the 'Saved Searches' folder – see below.

To remove all searches from the list, right-click on the 'Search History' folder and select *clear*. Note: Individual entries cannot be removed here, unlike 'Saved Searches'...

### Saved Searches

This folder contains searches that have been saved via right click from 'Search History'. Entries dragged from 'Saved Searches' and dropped onto real folders within 'Local' or 'User' will create a folder containing copies of all found presets. To remove individual saved searches, right-click on the search and select *delete*.

### Favourites

8 smart folders, one for each Favourite colour. See [Presets context menu](#). Presets dropped onto one of the Favourites folders will be marked as such.

### Junk

A smart folder pointing to all junked presets. See [Presets context menu](#). Presets dropped onto this folder will be junked, and will therefore disappear from the rest of the browser unless made visible (see *show junk* in the [Presets context menu](#)).

### Tags

Smart folders for each *Category/Subcategory*, *Features* and *Character* tag. Presets dropped onto these folders will adopt the corresponding tag. Presets dropped onto the *[no Tags]* folder will have all *Category/Subcategory*, *Features* and *Character* tags removed.

### Author

Smart folders for each *Author*. Tip: Instead of signing each of your creations, you could sign just one of them, then select them all and drag them onto *Author/(You)/*. As the process cannot be undone, you should use this feature with caution.

# 3 SYNTH

This section explains the various modules available in the SYNTH panel, starting with the oscillators. Click on the SYNTH button at the top left to see this panel:

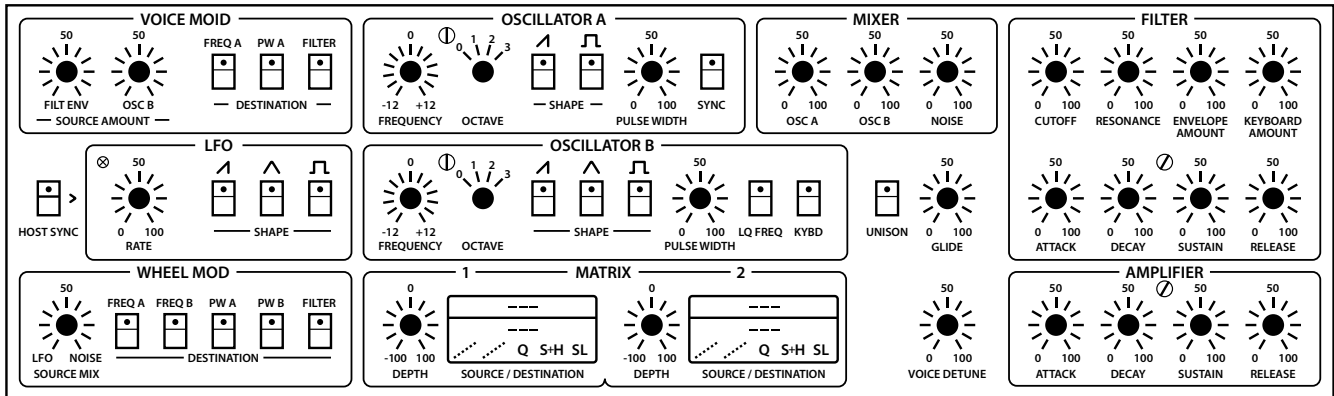

The layout is fairly simple, with modulation parameters on the left, oscillators in the centre and filter / amplifier settings on the right. Let's start with the oscillators...

## 3-1 OSCILLATOR A

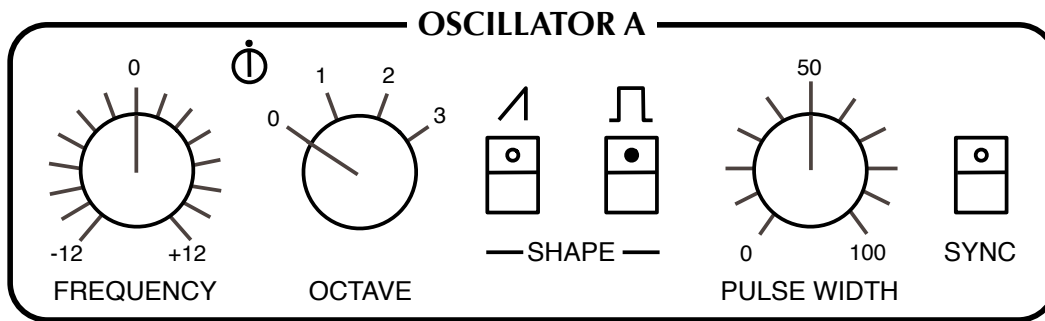

**FREQUENCY** knob: Adjusts pitch within a two-octave range (+/- 12 semitones).

**FINE TUNING** trimmer (between FREQUENCY and OCTAVE): Adjusts pitch within a range of +/- 20 cents. Its main purpose is to adjust the rate of beating between the two oscillators when they are tuned almost in unison.

**OCTAVE** rotary switch: Transposes oscillator pitch over a four-octave range.

**SAWTOOTH SHAPE** button: Activates the standard brassy waveform containing all harmonics (odd as well as even).

**PULSE SHAPE** button: Enables a waveform with a harmonic content that depends on the PULSE WIDTH setting, but sounds generally more hollow than the sawtooth.

Note: If neither **SHAPE** is switched on, OSCILLATOR A is silent.

**PULSE WIDTH** knob: Adjusts the harmonic content of the pulse wave by setting its “duty cycle”. The range is from 0% to 100%. Double-click on the knob for a 50% pulse (a clean square wave containing odd-integer harmonics only).

Note 1: At extreme values, the signal gets so thin that it becomes silent (DC, direct current).

Note 2: The PULSE WIDTH knob has no effect on the shape of the sawtooth wave.

**SYNC** button: Hard synchronization forces the waveform of OSC A to reset whenever OSC B hits zero. The frequency of OSC A generally needs to be higher than OSC B for this to work properly. Experiment: Intermediate FREQUENCY values can produce unusual timbres at the next lower harmonic of OSC B.

### 3-2 OSCILLATOR B

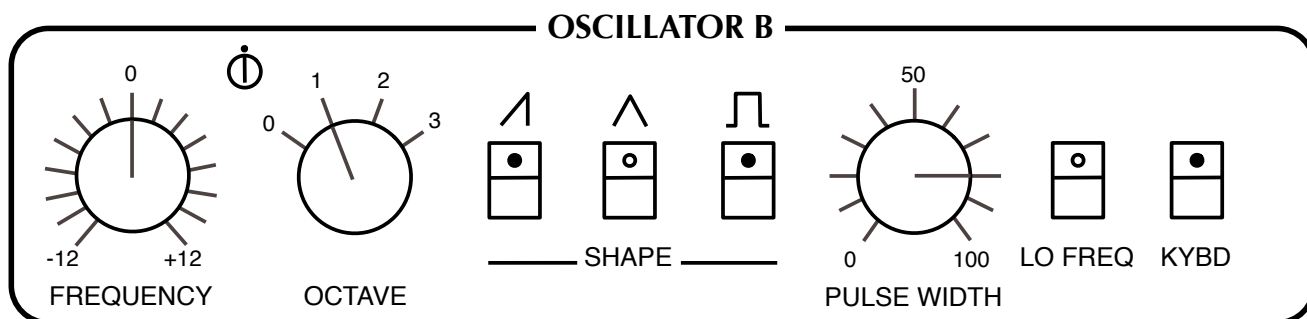

The same as oscillator A, minus the SYNC button but with the following extras:

**TRIANGLE SHAPE** button: The triangular waveform is bipolar, so it doesn’t add any DC to the modulation when used as an LFO. As an audio signal, the triangle has very little “bite”, but can be used to boost the fundamental frequency.

**LO FREQ** button: Extends the range of oscillator B down to the sub-audio frequencies suitable for use as an LFO.

**KYBD** button: Switching this off disables keyboard follow, resulting in a constant pitch which is independent of the played note.

### 3-3 MIXER

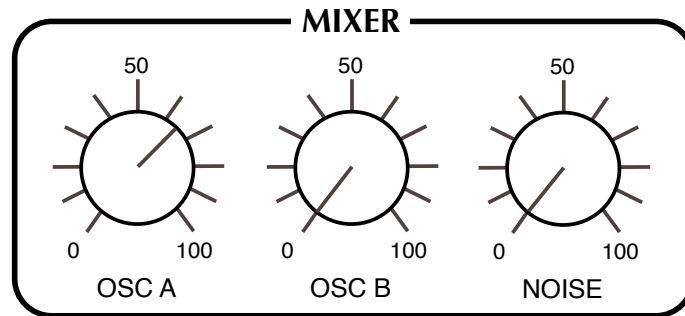

**OSC A** and **OSC B** knobs: The output levels of each oscillator.

**NOISE / FEEDBACK** knob: When labelled NOISE, this knob sets the output level of the noise generator (an unpitched audio source useful for wind and percussion effects etc.). A jumper in the TWEAKS page replaces this function (and the label) with FEEDBACK. The knob then controls the amount of signal fed from behind the amplifier back into the MIXER – useful for boosting bass frequencies, for instance.

### 3-4 UNISON, GLIDE & VOICE DETUNE

To the right of oscillator B is an open area of the panel containing the following three controls:

**UNISON** button: When this is activated, Repro-5 will assign all available voices to single notes. The number of VOICES is set in the control bar. Stacking all 8 voices with some extra detuning, UNISON can deliver a truly massive lead sound.

**GLIDE** knob: This is only effective while UNISON is switched on. Glide (also known as Portamento) slurs the transitions between consecutive notes. At zero, the pitch jumps instantaneous, while values above 50 cause it to glide very slowly.

**VOICE DETUNE** knob: Effective at all times, independent of UNISON status. Per-voice subtle to serious detuning, as well as various other offsets.

Tip: To ensure that repeating the same note doesn't apply exactly the very same detuning every time, go into the TWEAKS view and set the REALLOCATE jumper to OFF.

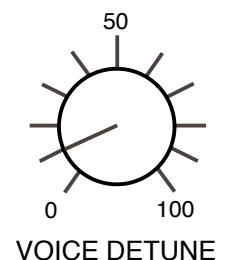
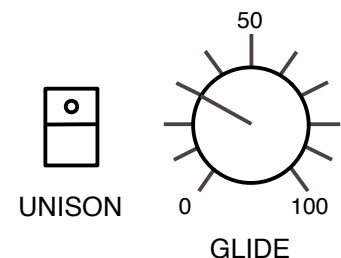

### 3-5 FILTER

**CUTOFF** knob: Adjusts the cutoff frequency for the 24 db/octave lowpass filter, which works a bit like a tone control. Lowpass “cutoff” is the frequency below which all components of the signal are allowed to pass, while most of the higher frequency components are suppressed.

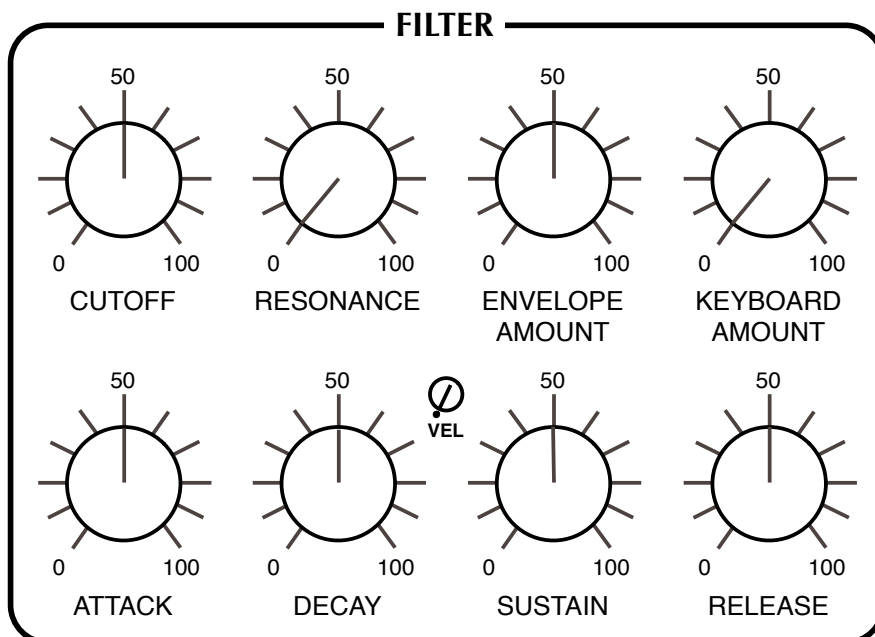

**RESONANCE** knob: Determines the amount of feedback within the filter circuit. The higher the resonance, the more the cutoff frequency will be accentuated. Above 60.00 the filter starts to self-oscillate – it becomes a sine-wave oscillator with pitch determined by Cutoff. Note that adding resonance tends to lower the volume, like in the original hardware.

**ENVELOPE AMOUNT** knob: The amount of cutoff modulation from the filter envelope.

**KEYBOARD AMOUNT** knob: The amount of cutoff modulation from the keyboard – the higher the note, the higher the cutoff. Set to 75.00, cutoff follows notes precisely so that it can be played “in tune” when the resonance is high.

The **filter envelope** is triggered whenever a note is played, and applies a contour to the cut-off. As long as a key is held down, the envelope proceeds through its **ATTACK** and **DECAY** stages, remains at the **SUSTAIN** level until the key is released, then drops to zero at a rate set by the **RELEASE** knob:

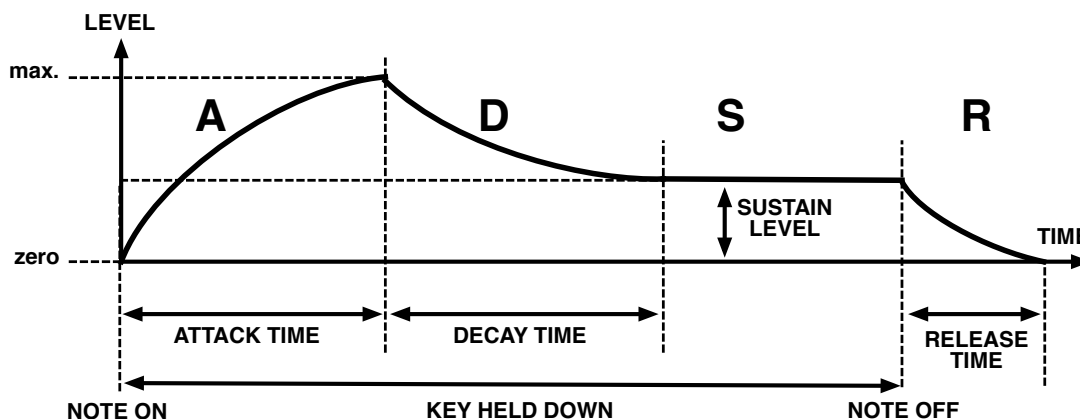

**ATTACK** knob: Varies the time for the envelope to rise from zero to maximum, within a range of about 2 milliseconds to more than 15 seconds.

**DECAY** knob: Varies the time for the envelope to fall from maximum to the SUSTAIN level, also within a range of about 2 milliseconds to more than 15 seconds.

**VEL** trimmer: Adjusts the amount of velocity modulation for the filter envelope. When set to maximum, minimum velocity will reduce the envelope level to zero.

**SUSTAIN** knob: The “hold” level, from zero to maximum. An interesting detail: while being adjusted, SUSTAIN always *decays* to the new level – the longer the DECAY, the longer it takes to reach the new SUSTAIN setting.

**RELEASE** knob: The time it takes for the filter envelope to fall from the current level (usually SUSTAIN) down to zero after the key is released. The range is 2 ms to about 55 seconds.

### 3-6 AMPLIFIER

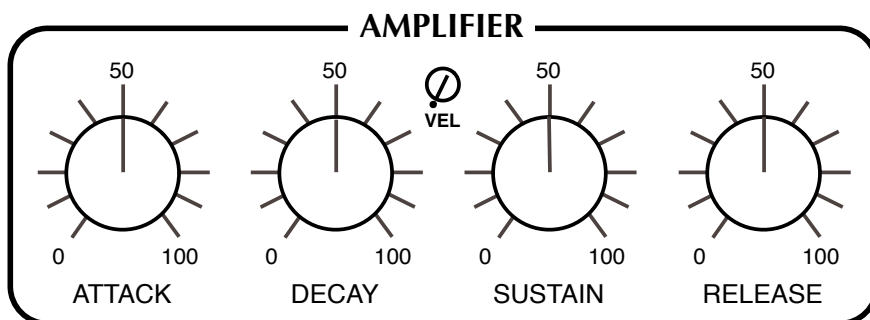

These controls shape the envelope applied to volume, pre-effects. The amplifier envelope is started whenever a note is played. As long as a key is held down, the envelope proceeds through the ATTACK and DECAY stages, remains at the SUSTAIN level until the key is released, then drops to zero at a rate set by the RELEASE knob.

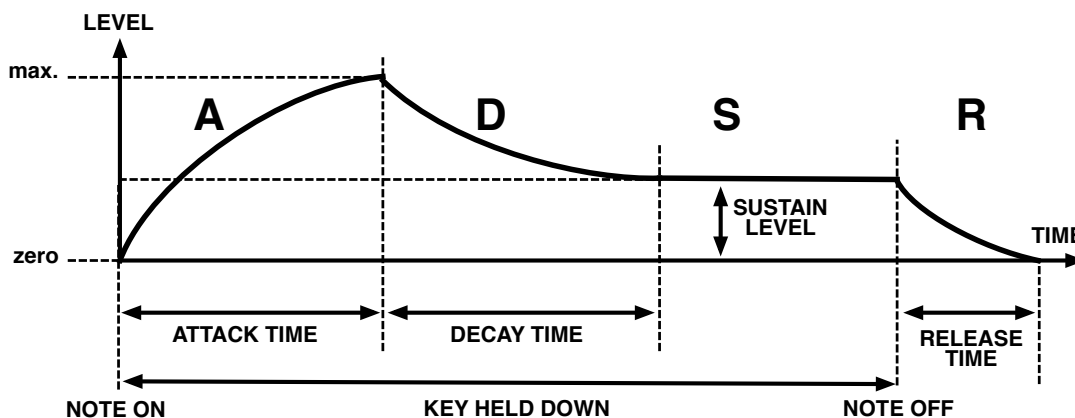



**ATTACK** knob: Varies the time for the envelope to rise from zero to maximum, within a range of about 2 milliseconds to more than 15 seconds.

**DECAY** knob: Varies the time for the envelope to fall from maximum to the SUSTAIN level, also within a range of about 2 milliseconds to more than 15 seconds.

**VEL** trimmer: Adjusts the amount of velocity modulation for the amplifier envelope. When this is set to maximum, **minimum** velocity will reduce the envelope level to zero i.e. silence.

**SUSTAIN** knob: The “hold” level, from zero to maximum. An interesting detail: while being adjusted, SUSTAIN always *decays* to the new level – the longer the DECAY, the longer it takes to reach the new SUSTAIN setting.

**RELEASE** knob: The time it takes for the amp envelope to fall from the current level (usually SUSTAIN) down to zero after the key is released. The range is 2 ms to about 55 seconds.

### 3-7 VOICE MOD

A synthesizer’s expressiveness depends largely on its modulation capabilities. In Repro-5, modulation is assigned in 3 different panels (VOICE MOD, WHEEL MOD and the MATRIX). VOICE MOD **routes the filter envelope and/or oscillator B to three destinations:**

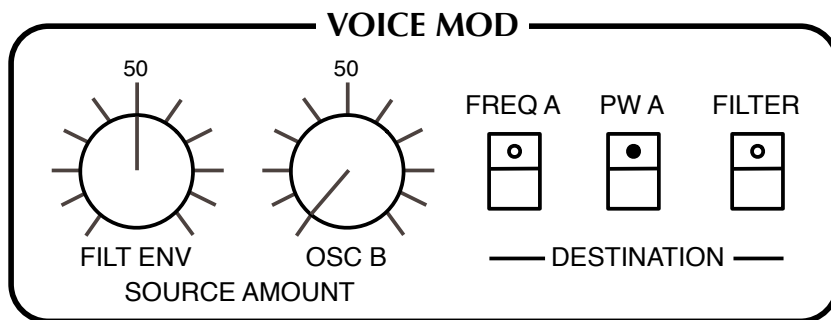

Both modulation sources here are “polyphonic”: Minuscule differences between the individual voices create effects that differ from note to note in subtle but interesting ways. This is unlike WHEEL MOD (see below), where just one signal modulates all voices in the same way.

**FILT ENV** knob: The amount of filter envelope sent to all selected destinations.

**OSC B** knob: The amount of oscillator B sent to all selected destinations.

**DESTINATION** buttons: These specify where the mixture of filter envelope and OSC B is to be sent: oscillator A frequency, oscillator A pulse width and filter cutoff.

### 3-8 LFO

Two of the basic modulation sources (filter envelope and oscillator B) were already mentioned in section 3-6. The third is the **Low Frequency Oscillator** (LFO):

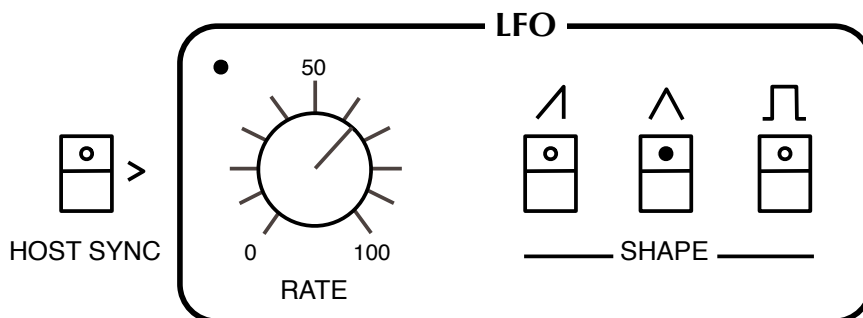

**HOST SYNC** switch: When this is activated, the LFO RATE switches between fixed divisions relative to the host tempo. Values are expressed as 4/4 bar divisions from 8/1 (slowest) to 1/64 (fastest). The *trip* options are **triplets** (3 in the space of 2) and the *dot* options are **dot-~~ted~~** (2 in the space of 3 i.e. 50% longer than normal):

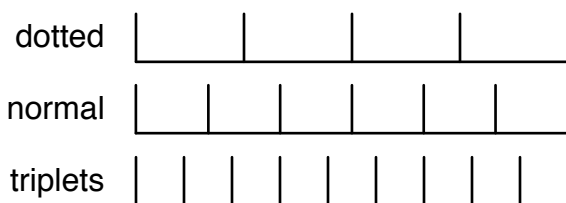

The order of values may appear strange at first (e.g. 1/4 then 1/8 dot then 1/4 trip), but you can rest assured that they are correctly sorted according to length.

If HOST SYNC is off, the rate can be freely adjusted between about 0.03 Hz and 27.5 Hz.

**SHAPE** switches: The same options as in OSC B except that the LFO's pulse width is fixed at 50%. Remember that you can add the shapes here e.g. SAW + SQUARE.

### 3-9 WHEEL MOD

Global modulation settings. A mixture of two sources, LFO and pink noise, is routed to five destinations: the frequency and pulse width of each oscillator, and filter cutoff.

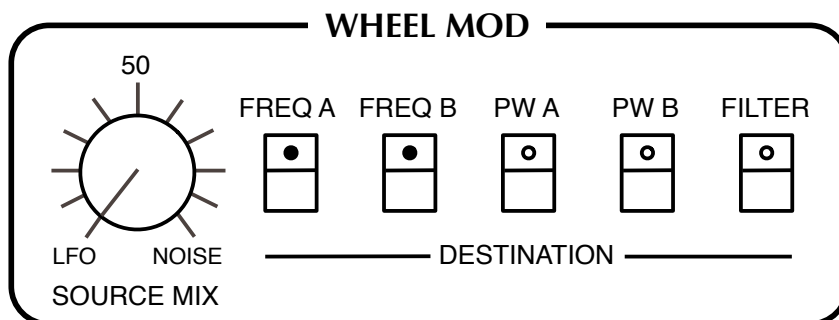

<b>Modulation Sources</b>		Voice Modulation	Osc B Amount Filter Env Amount
Mod Wheel (MIDI CC#01) Pitch Wheel Control A (default = Breath i.e. CC #02) Control B (default = Expression i.e. CC #11) LFO _____		Voice Detune	Amount
Trigger (see previous page) Gate Key Follow Key Follow +PB Velocity Aftertouch Filter Envelope Amp Envelope Voice Index (see previous page)		Mixer	Osc A Osc B Noise/Feedback
		Filter	Cutoff Resonance Keyboard Amount Envelope Amount
		Distortion	Amount Tone Mix Rate Crush
<b>Modulation Destinations</b>		Stereo Pan	Pan 1 Pan 2 ... Pan 7 Pan 8
LFO	Frequency – only while HOST SYNC disabled		
Global Modulation	LFO/Noise Mix Lower Limit Upper Limit	Velvet	Input Gain
Glide	Amount	Lyrebird	Delay Time Regeneration Mix
Pitch	Master Tune	ResQ	Bass Frequency Bass Gain(EQ) Bass Vol (Res) Mid Frequency Mid Gain (EQ) Mid Vol (Res) High Frequency High Gain (EQ) High Vol (Res) Q/Resonance
Filter Envelope	Attack Decay Sustain Release		
Amplitude Envelope	Attack Decay Sustain Release		
Oscillator A	Frequency * Fine Tune Pulse Width	Drench	Pre-Delay Decay Tone Dry/Wet Mix
Oscillator B	Frequency * Fine Tune Pulse Width	Sonic conditioner	Gain Stereo Width Transient

\* Restricted to the FREQUENCY range, for technical reasons

The depth of modulation is normally set by the position of the **modulation wheel** to the left of the keyboard. Unlike the original hardware, however, in Repro-5 you don't actually have to push the mod wheel to get any modulation at all – the **lower limit** (see [WHEEL MOD LIMITS](#) on page 5) can be used to set a permanent minimum amount.

**SOURCE MIX** knob: From 100% LFO signal, through 50% LFO / 50% noise to 100% noise. The original idea was probably to facilitate more organic-sounding cyclic modulation, but SOURCE MIX can help while emulating the sounds of heavy industrial machinery!

**DESTINATION** buttons: Select frequency and pulse width of each oscillator, and/or cutoff.

Note: The LFO isn't strictly global, as its Rate can be forced to differ between voices, for instance by modulating Rate with Key Follow in the MATRIX.

### 3-10 MATRIX

In the lower centre of the panel is a 2-slot modulation matrix you can use to extend Repro-5's modulation capabilities.

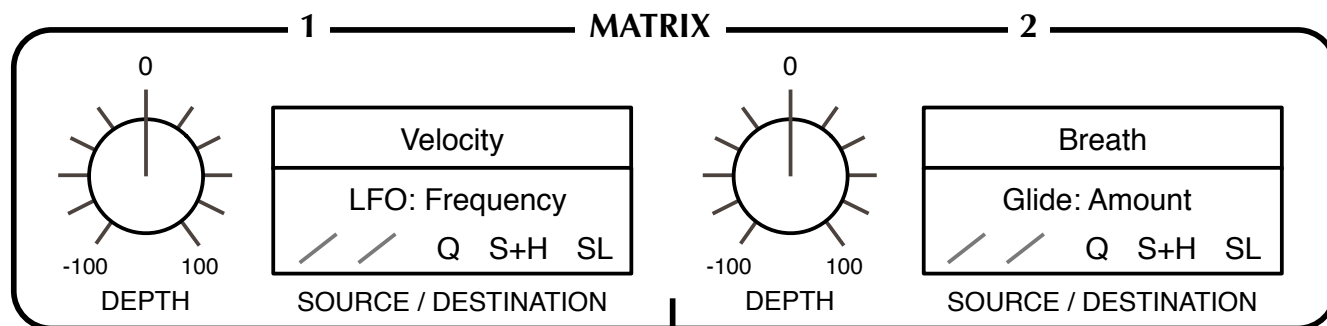

To select a **SOURCE**, click on one of the upper selectors. Right-clicking on the lower selector opens a menu where you can choose a **DESTINATION**. Note: Effect parameters will only appear in the destination menu if the corresponding effect is currently active.

**Drag & Drop** is a very comfortable alternative method of assigning the destination. Left-click on the lower selector, drag the crosshair onto any valid control (it will be highlighted), then release the mouse button.

On the next page is a list of **all modulation sources and destinations**. Two of the **sources** might need a little explanation...

*Trigger* is a very short impulse derived from the Gate of each note. You can use it to add punch to a sound by modulating oscillator frequency, filter cutoff or Distortion amount, for instance.

*Voice Index* is a modulation source derived from the 'number' of the played voice (from 1 to maximum 8). You can use it as a general-purpose [VOICE DETUNE](#) to modulate any parameter by a quasi-random amount.

## Slot Modifiers

Immediately below the target selectors are buttons used for choosing **slot modifier** options which process the modulation signal before it reaches the target. From left to right these are: *Curve*, *Rectify*, *Quantise*, *Sample & Hold Trigger* (S+H) and *Slew Limiter* (SL).

### Curve

These options let you ‘map’ the modulation source onto an s-curve. A bipolar ramp e.g. from the LFO or the pitch bender would be transformed into one of the following curves, while a positive unipolar source would only use the upper half of each curve:

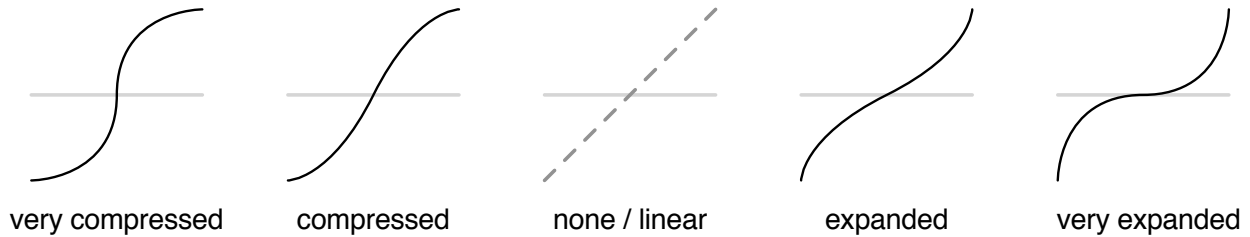

### Rectify

Half-wave or full-wave rectification, positive or negative, plus *unipolarize*. The symbols show how a bipolar ramp wave (like ‘none’ here) would appear after rectification.

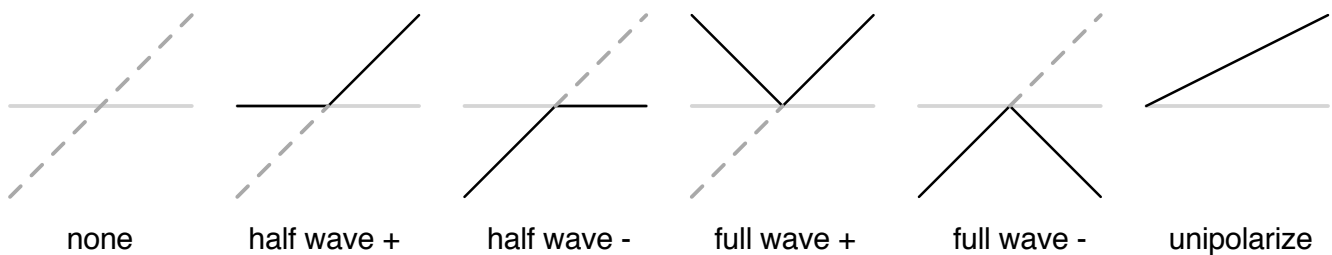

<i>half wave +</i>	removes negative values
<i>half wave -</i>	removes positive values
<i>full wave +</i>	folds negative values up into the positive
<i>full wave -</i>	folds positive values down into the negative
<i>unipolarize</i>	shifts the signal to positive-only

## Quantize

After applying a curve, the modulation signal can be forced to adopt certain discrete values.

The *integer* setting makes the modulation typically “steppy”. The *steps of 12* option transforms bipolar sources into max. 5 values (unipolar = maximum 3). All other options quantize the output to scales, so they are mainly useful for pitch control.

<i>overtone series</i>	harmonic overtones
<i>minor / major scale</i>	natural minor, regular major
<i>minor / major chord</i>	chord tones (root, third fifth)
<i>minor / major series</i>	third intervals (repeats after two octaves)
<i>fifths and octaves</i>	well, it’s fifths and octaves only!

Note: Quantization is applied **after** modulation depth, so lower depth means fewer steps.

## Sample & Hold Trigger (S+H)

*Mod Wheel, Pitch Wheel, Control A, Control B, LFO, Gate or Aftertouch.*

Whenever the selected signal crosses zero in the positive direction, the modulation source will be sampled and held i.e. stepped.

## Slew Limiter (SL)

Softens transitions in the modulation source. The options are: *none, fast, smooth* or *slow*.

## 4 TWEAKS

Apart from being unashamed eye-candy, the TWEAKS page is there to let you change the fundamental behaviour of individual modules. In the current version there are 10 **jumpers** (circuit connectors) and 6 module option **selectors** (not including the 4 MATRIX source and destination selectors, which don't really count as "tweak" elements):

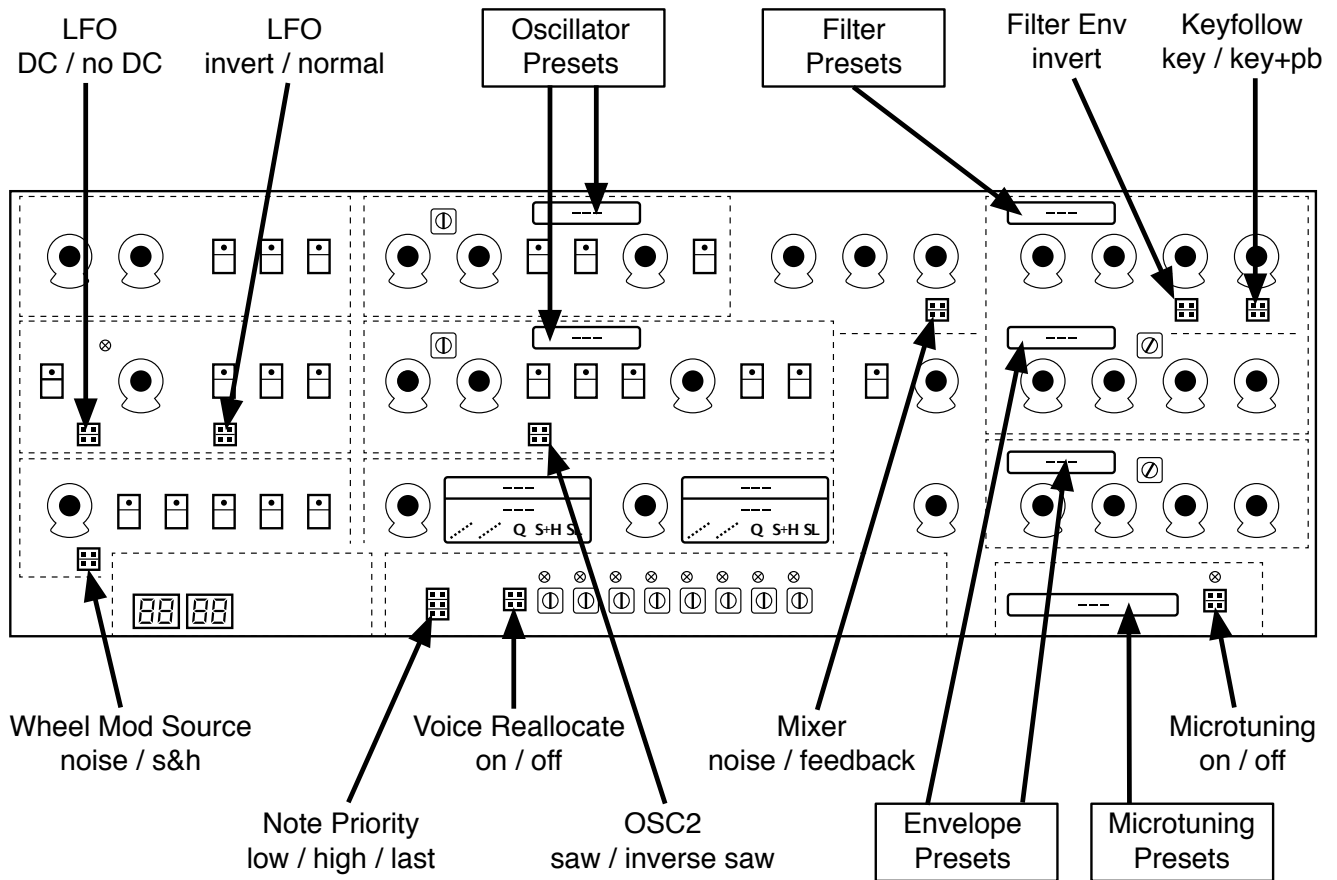

Although the knobs and switches actually work, the labeling has been kept simple and cryptic on purpose, in keeping with the 'circuit board' theme.

*The TWEAKS page is meant to be eye-candy!*

### 4-1 JUMPERS

**LFO DC|NO DC:** With the jumper in the DC position, both the square and saw waves are positive-only (unipolar). The NO DC option makes them both bipolar. Note that the LFO triangle wave is always bipolar, whatever the position of the jumper.

**LFO INV|N:** Inverts the sawtooth. In the normal (N) position it is a rising sawtooth, in the INV position it is a falling sawtooth.

**WHEEL MOD S&H|Noise:** Setting this jumper to the S&H position replaces the pink noise signal with random steps (noise sampled at the LFO rate).

OSC B **INV|N**: Inverts the sawtooth. In the normal (N) position it is a rising sawtooth, in the INV position it is a falling sawtooth.

UNISON / **NOTE PRIO** (note priority) on the lower board: This jumper sets how Repro-5 reacts when you play more than one note at a time when unison is switched on. LOW plays the lowest note (like the original hardware as well as other USA-designs), HIGH plays the highest note (EMS and most Japanese synths), LAST plays the most recent note (modern, typical of digitally controlled synths).

POLY VOICE / **REALLOCATE**: Determines whether the same note will trigger the same voice (reallocate ON), or distribute voices *round-robin* (reallocate OFF). Turn the VOICE DETUNE knob up a little, repeat the same note and watch the voice activity indicators!

MIXER **FB|NOISE**: Switching this jumper over to “FB” replaces the usual NOISE with audio FEEDBACK. The knob then controls the amount of signal fed from behind the amplifier back into the MIXER – useful for boosting bass frequencies, for instance.

FILTER –|+: Setting this to “–” inverts the filter envelope signal (ENV AMOUNT).

FILTER **KEY|KEY+PB**: In the KEY position, the pitchbender doesn’t affect cutoff, while in the KEY+PB position it does.

**MICROTUNING ON|OFF** for the selection: See *Microtuning* on the next page.

## 4-2 SELECTORS

All red fields are selectors – either click and select one of the options or simply hover over them and roll your mouse wheel (no click required).

### PITCH RANGE

The pair of selectors on the extra circuit board at the bottom left are for adjusting the range of the pitch bender. The options are 0 through 24 i.e. two octaves in semitone steps, then either three or four octaves (36 / 48 semitones).

### Oscillator tweaks

The two selectors above the oscillator SHAPE buttons. The standard setting for Repro-5 is *P5*, while *P1* was adopted from Repro-1. The *ideal* option has a crisper, more precise sound. The most obvious difference between P5 and P1 is that the P5 pulse wave is inverted (that’s why P1 is much quieter when Saw and Pulse are both switched on). A less obvious difference is that OSC A in P5 mode retains very little of the fundamental frequency when SYNC is on.

*P5 Old* is a highly detuned version of the regular P5.

Only available in OSC B: *Bottom* emphasizes the TRIANGLE shape.

### Filter tweaks

*Crispy*, *Rounded*, *Driven* or *Poly*: The first two accurately model the filters in the two synths we bought especially for Repro-1 analysis. Most obviously, cutoff in *Rounded* is a few semitones lower than it is in *Crispy*, and there are also significant differences in the resonance behaviour. *Driven* is the result of balancing internal filter parameters in search of a novel 3320 flavour – we like it! Finally, *Poly* is an approximation of the filters in Repro-5’s grandad. The cutoff is significantly lower – doesn’t reach max. unless modulated upwards e.g. by the filter envelope.



## Envelope tweaks

*Ideal:* Non-linear but consistently clean ADSR.

*Analog:* Includes more imperfections typical of real analogue circuitry.

*High Sustain:* Emulates an interesting fault (“quirk”) in some versions of the hardware synth we used to create *Repro-1*: The end of the Attack stage doesn’t quite reach Sustain levels above about 85 – it simply jumps up the last 15%.

*One Shot:* The gate is ignored, the Decay stage continues until it reaches the sustain level, which is immediately followed by Release. This type of envelope is particularly suitable for percussion sounds, fly-by effects etc..

*Piano 1/2:* These two modes were implemented according to a rather geeky article in the magazine *Electronics and Music Maker* (affectionately known as *E&MM*) all about the CEM 3310 envelope chip. In both *Piano* modes the Attack and Decay stages are the same as in *One Shot* mode. However, if the key is lifted during the Release stage there is an extra (true) re-release, which is longer in *Piano 1* than in *Piano 2* mode.

## Microtuning

At the bottom right of the TWEAKS view is a beige-coloured circuit board with a selector and a jumper switch. Click on the selector to open an overlay window..

*Repro-5* supports standard .TUN microtuning tables, and you will find several in the list already. Many more tuning tables are available online, most of them free. The .tun files belong in the following folder on your hard drive (assuming standard installation paths):

**Win** C:\Users\\*YOU\*\Documents\u-he\Repro-1.data\Tunefiles\  
**Mac** MacHD/Library/Application Support/u-he/Tunefiles/

Just like in the main browser you can right-click on any .tun file and select *Show in Finder/Explorer*. To close the microtuning browser again, click on the [CLOSE] button at the top right.

### New in version 1.1.2 – MTS-ESP

*Repro-5* now supports Oddsound MTS-ESP, a system for microtuning multiple plug-ins within a DAW environment. The freeware ‘Mini’ version is all you need to get started. MTS-ESP can be overridden by activating *Repro-5*'s microtuning, for instance with the .tun file *Default Scale*.

## 4-3 VOICE PANNING

Apart from the single trimmers for oscillator fine tuning and envelope velocity, there is a row of eight identical trimmers on a separate board at the bottom of the TWEAKS view...



These set a stereo pan position for each individual voice. Turn down to minimum for hard left panning, turn up to maximum for hard right panning, double-click to return to the centre. See also Reallocate a few pages back.

# 5 EFFECTS

The **FX** button in the bottom lefthand corner toggles between the keyboard and FX views. The

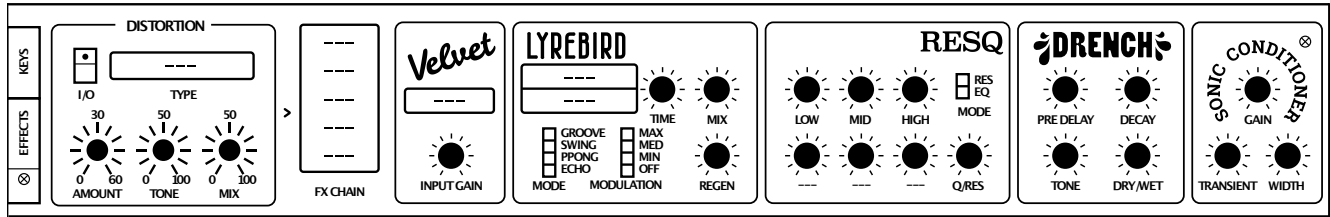

**BYP** (effects bypass) button above it is for comparing the treated and untreated sound. Please remember that the **BYP** (effects bypass) status is global – bypass won't automatically switch off when you select another preset, but will remain on until you click on the button again. If most of your presets sound strangely dry today, you will know where to look first!

## 5-1 DISTORTION

Repro-5's distortion unit is polyphonic. Each voice has its own processor, so there is no interaction between notes in a chord. Although it wasn't what sparked the idea for including a per-voice distortion unit in repro-5, Edgar Froese (of Tangerine Dream) once attached an Elektro-

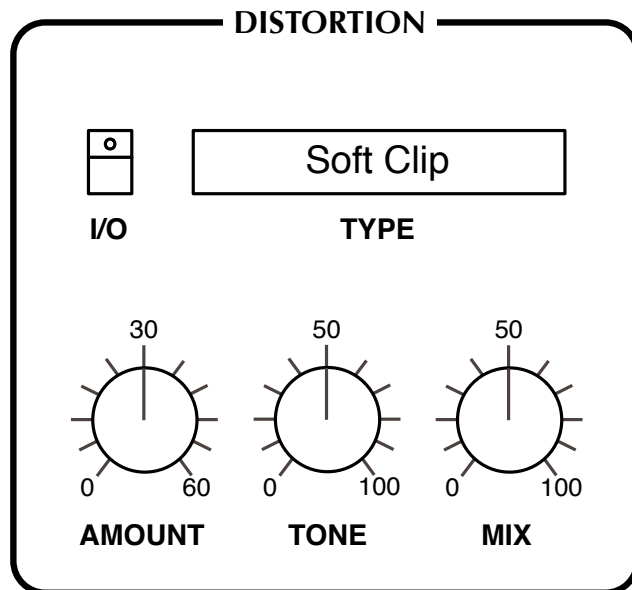

Harmonix "Big Muff" fuzzbox to each of the five outputs of his modified SC Prophet-5.

**I/O** (in/out) button: Switches distortion in or out of the signal path.

**TYPE** selector:

*Soft Clip* smoothly compresses peaks in the signal.

*Hard Clip* simply chops off the top and bottom of the waveform.

*Foldback* is similar to soft clip except that increasing the gain doesn't slam more of the signal peaks against the limits, but reflects (folds) them back.

*Corrode* is a sample rate reducer and bit crusher in one. In this mode, the Amount and Tone controls (see below) are replaced by Rate and Crush.

**AMOUNT** knob: Input gain in Decibels, controls the perceived amount of distortion.

**RATE** knob (replaces AMOUNT when the type is 'Corrode'): Reducing the sample rate of a signal degrades its quality – medium values introduce high-pitched grit, and high values create rough metallic tones which are louder than the dry signal. Rate reduction is particularly interesting when applied to softer sounds, with low cutoff.

**TONE** knob: A frequency tilt control for more bass or more treble distortion.

**CRUSH** knob (replaces TONE when the type is 'Corrode'): The bit-crush amount – the signal becomes increasingly steppe. Try it on a pure triangle wave first!

**MIX** knob: Dry/Wet balance control. Turning MIX down from the usual maximum preserves more of the original character without affecting the distortion characteristics.

## 5-2 FX CHAIN

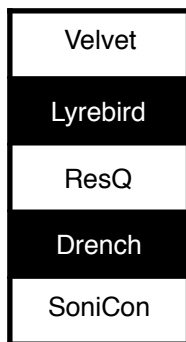

The block to the right of the distortion panel is for activating and reordering the other five effects. Click on individual cells to activate/deactivate them, drag & drop to change the order (the signal flows from top to bottom of the FX chain).

### 5-3 VELVET tape saturation

Based on u-he's SATIN effect plug-in, this little unit adds the kind of colouration and distortion that is typical of magnetic tape recorders. It can be used at the end of the the FX chain for subtle sheen, or (for instance) before RESQ for more obvious distortion effects.

Note: Velvet's distortion is fundamentally different from the polyphonic Distortion, as notes played together will interact like in a guitar amplifier. Of course you can use a bit of both!

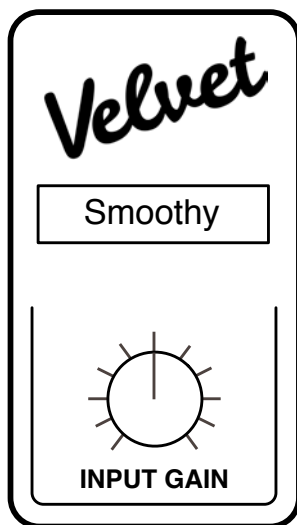

**PRESET** selector: Selects one of the factory presets.

**INPUT GAIN** knob: Signal cut/boost, effectively the amount of tape saturation/distortion.

## 5-4 LYREBIRD delay

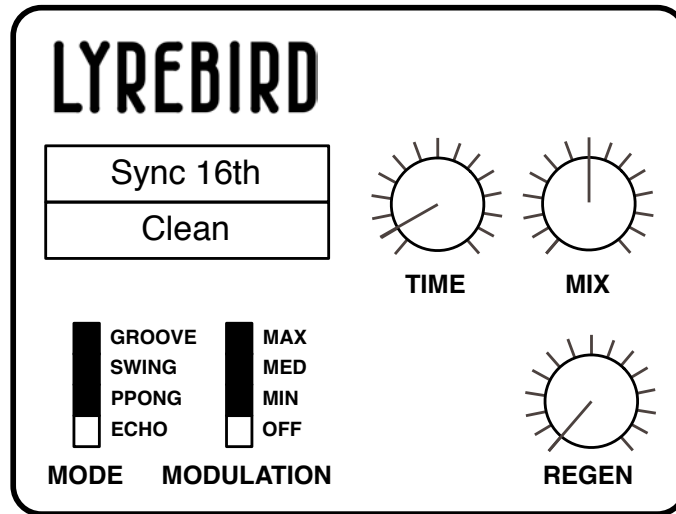

Lyrebird models an analogue (*bucket brigade* type) delay, capable of unsynchronized effects anywhere between flanging (i.e. modulated, very short delays) and 2 seconds, or host-tempo-relative delays between 1/16 and 8/1. In either mode, the delay time can be continuously fine-tuned.

**Sync** (upper selector): *Chorus/Short*, *Unsync/Long*, *Sync 1/16* or *Sync 1/4*. The first two options are absolute times, not relative to host tempo. As the name implies, the *Chorus/Short* option sounds especially rich with plenty of modulation (see below). *Unsync/Long* is usually the best choice for larger spaces and non-rhythmic effects.

**Flavour** (lower selector): Three different tonal characteristics for the decaying effect (*Clean*, *Bright* or *Dark*). Try them all out and compare results.

**MODE** switch: Affects the ratio between delays in the left and right channels: *Echo* has equal delay times in both channels (so the effect is monophonic unless modulated). *Pingpong* alternates evenly between the left and right channels, *Swing* creates triplets and *Groove* does dotted times.

**MODULATION** switch: Time modulation LFO rate. Switching to *OFF* disables the LFO.

**TIME** knob: Scales the Delay Sync value. For the synchronized delays this is literally a 1 to 8 multiplier, while for unsynchronized delays the range is much wider. Tip: Try turning REGEN up and modulating TIME – the pitch glides very smoothly, just like a real analogue or tape delay unit.

**MIX** knob: The volume ratio between unprocessed and processed signal.

**REGEN** knob: *Regeneration* determines how much of the processed signal is fed back into Lyrebird's input. At maximum, the feedback lasts longer than you will ever need...

## 5-5 RESQ resonator / equalizer

Depending on the status of the MODE switch, RESQ is either a semi-parametric EQ with two shelving filters surrounding a midrange band, or a triple bandpass resonator:

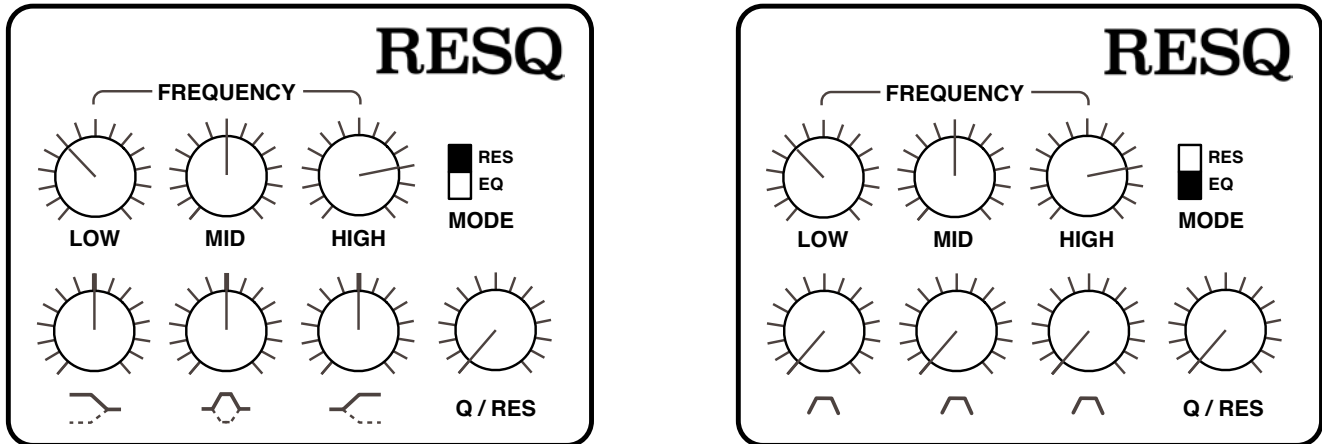

The **FREQUENCY** knobs adjust the cutoff for each band. The bands can seriously overlap or swap positions, so those labels shouldn't be taken too literally. The ranges of the knobs are approximately as follows:

LOW	=	45 Hz to 3 kHz
MID	=	55 Hz to 9 kHz
HIGH	=	130 Hz to 10 kHz

**GAIN knobs (EQ mode):** Centre-zero controls for cutting or boosting the level of each band by up to 18dB. In EQ mode, LOW and HIGH are shelving filters (as indicated by the labels).

**VOLUME knobs (RES mode):** The amplitudes of three resonant bandpass filters. The knobs are not centre-zero in RES mode, but positive only.

**Q (quality) / RES (resonance) knob:** The *Q-factor* of a filter band characterizes its width relative to its cutoff frequency. In EQ mode, Q only applies to the MID band.

## 5-6 DRENCH reverb

A typical lush plate reverb – but with an atypical pre-delay!

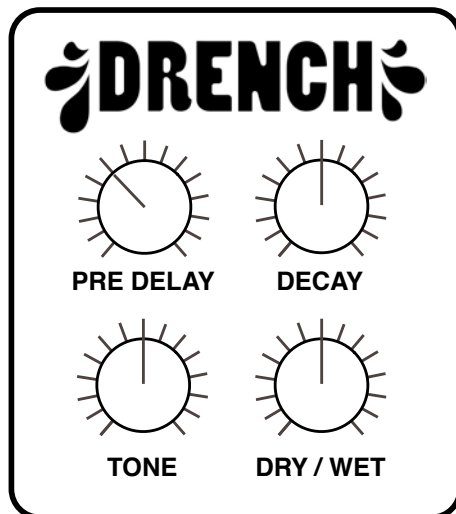

**DRY/WET knob:** The amount of reverb as a percentage of the total output.

**PRE DELAY knob:** A simple delay before the reverberation appears. This is especially useful for retaining the presence of the dry signal while simulating larger spaces, but it can also be adjusted to support a delay from Lyrebird, for instance.

**DECAY knob:** The length of the reverb tail. At the maximum setting (100), it can take several minutes for the effect to reach absolute silence.

**TONE knob:** A tilt filter, from very dark at -100 to very bright at +100. TONE simulates the softness / hardness of surfaces. Note: At these extreme values, the wet signal almost (but not quite) disappears.

## 5-7 SONIC CONDITIONER

Is the signal too loud or too soft? Is the stereo too extreme? Is your bass sequence too clicky, or does it lack punch? Then you should try the SONIC CONDITIONER...

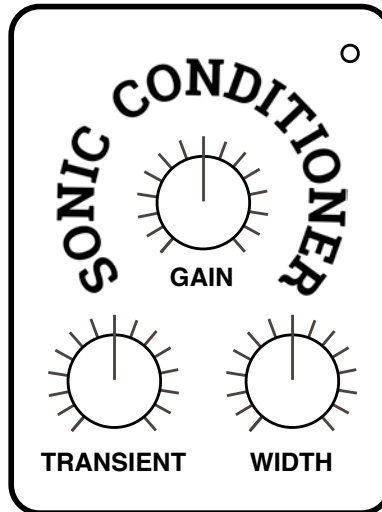

On the top right is a load indicator which gets brighter as the signal is saturated.

**GAIN** knob: Bipolar control for the output level. Settings above zero (the centre) will saturate the signal – a useful effect in its own right. You can compensate for high GAIN by turning Re-pro-5's main OUTPUT level down.

**TRANSIENT** knob: Bipolar control over the percussive elements within a signal. Set negative values to reduce clicks or positive values to add punch. Caution: Negative TRANSIENT can cause crackling with bassy material and pads – in this case, try turning it up until the crackling only just disappears.

**WIDTH** knob: A stereo spread control. Especially useful for keeping delay or bias-modulated wavefolder effects more focussed in the centre of the stereo field.

### Caution

Applying *Transient* (either positive or negative) to big polyphonic sounds can result in unpleasant distortion due to the process being triggered by complex low frequencies.



## 6 CONFIGURATION

A click on the **red button** at the top right opens the global configuration pages where you can adjust the appearance and performance or connect Repto-5 parameters to MIDI controls:



You can specify which particular page (e.g. PREFERENCES) will open whenever you click on the configuration button: Right-click anywhere in this row and select *set current as default*.

### 6-1 ABOUT MIDI CC

CC, which now officially stands for Control Change (no longer Continuous Controller) is a multi-purpose message format used for editing and performing presets. CC isn't the only kind of MIDI performance data. For instance, there are different messages for note on/off (including velocity), pitch bend and two kinds of aftertouch.

Although the MIDI Manufacturers Association (MMA) was kind enough to leave most of the 128 CC numbers undefined, two have specific meanings that Repto-5 also recognizes:

- 01 = modulation wheel
- 64 = sustain pedal

Repto-1 version 1.0 also offered the performance modulation sources *Breath* (CC 02) and *Expression* (CC 11). In Repto-1 as well as Repto-5, these have been replaced by the user-definable *Control A* and *Control B*. See section 6-4 [PREFERENCES](#).

By the way: You don't actually need a breath controller (for instance) or an expression pedal to make use of CC messages. Most of the names are purely convention these days. You can use anything that can send a definable CC e.g. a couple of knobs on your MIDI keyboard or a controller lane in your MIDI sequencer.

Later MMA revisions to the MIDI spec even included a bunch of esoteric CC definitions such as 'Celeste Detune Depth', probably at the request of a home organ manufacturer or two. We can safely ignore all such definitions!

### 6-2 MIDI LEARN

The MIDI LEARN page is where you can connect MIDI CC (see above) to almost any Repto-5 parameters. The MIDI data can be generated by adjusting the knobs or faders on a hardware controller, for instance, or by a track in your sequencer.

Learnable elements appear as selectable outlines. Controls that are already connected appear filled, while the outline of the control waiting to be MIDI-learned is highlighted white.

Try it: Click on the Cutoff knob (it is then highlighted) and send Repto-5 some MIDI CC data by adjusting a knob or fader on your MIDI controller. To remove the assignment, double-click on that same control or go to the MIDI Table (see below).

Note: You can access all parameters without exiting MIDI LEARN. Simply switch between the SYNTH and TWEAKS pages, or between the KEYS and EFFECTS.

## 6-3 MIDI TABLE

To open an editable list of all current MIDI CC assignments, click on the Configuration button (cogwheel top right) and select MIDI TABLE.

**Parameter:** The first field selects a Repr0-5 parameters from submenus sorted according to module. Click on the **Add** button at the bottom left and experiment with this field, then delete the assignment again by clicking on the small [X] to the right of the line you just created.

**Channel / Controller:** The next two fields are for the MIDI channel and CC number. Repr0-5 is channel-sensitive – you can map up to 16 channels for a total of... well, more than enough assignments for Repr0-5!

**Mode:** Specifies the range and/or resolution of values.

*Normal* .....full range, continuous

*Integer* .....full range, whole numbers only

*Fine* .....0.01 steps between the integers closest to the current value

**Type:** Specifies the type of hardware (by far the most common is *Continuous 7-bit*).

*Encoder 127* .....‘relative mode’ endless rotary controls that repeatedly send the CC value 1 when turned in the positive direction, or 127 (interpreted as -1) when turned in the negative direction

*Encoder 64* .....‘relative mode’ endless rotary controls that repeatedly send the CC value 65 when turned up, or 63 when turned down

*Continuous 7-bit* .....7-bit MIDI CC (normal resolution, very common)

*Continuous 14-bit* .....14-bit MIDI CC (high resolution, less common)

**Removing assignments:** The small [x] to the right of each line removes that assignment. The MIDI table can be cleared by clicking on the [Delete All] button at the bottom of the window.

**Experimental feature:** Click on **Add**. At the very bottom of the *Parameter* menu you will see two options called *Last Clicked Control* and *Last Clicked Control Fine*...

Select *Last Clicked Control*, enter a suitable controller (MIDI CC) and exit the configuration pages. The most recently clicked knob/switch will now respond to that CC. The *Fine* option is similar, but with a significantly reduced range.

## 6-4 PREFERENCES

For the following options, click on the cogwheel button at the top right of Repro-5's window and select the PREFERENCES tab:

### CONTROLS

---

**Mouse Wheel Raster:** If your mouse wheel is rastered (it clicks as you roll the wheel), set this option 'on' so that each little click increments the value in 'sensible' steps.

**Scroll Horizontal:** Any preset folders that contain more files than can be displayed in the window can be scrolled pagewise via mousewheel etc.. Opinions differed as to which wheel direction should move to the bottom of the list, so we made this optional!

**Switch Behaviour:** The *drag* option here requires that you drag the TWEAKS page jumpers up/down, while *toggle* lets you click anywhere on 2-state switches. the *iterate* option is like *toggle* except that it also applies to 3-way switches, with the downside that clicking on the target position no longer works. Irrespective of this setting, the jumpers respond to rolling the mouse wheel just like the knobs – no clicks required!

### APPEARANCE

---

**Default Size:** The GUI size for each new instance of the plug-in.

**Default Skin:** This option will only appear if Repro-5 finds at least one alternative skin when it loads. Change this option to set the global default.

**Gamma:** Adjusts the overall brightness of the Repro-5 window.

**Text Antialiasing:** Turns the smoothing of labels and values on or off. Usually left on!

### PRESETS

---

**Auto versioning:** If this option is switched on, an index is appended to the preset name and automatically incremented each time you save it. For instance, saving 'Space' three times in a row would give you three files: 'Space', 'Space 2' and 'Space 3'.

**Save Presets To:** Choosing *user folder* here causes all saved presets to land in the *User* folder.

**Scan On Startup:** Whether the preset library should be scanned and the database recreated when the first instance of Repro-5 is started, e.g. when you reopen a project.

### OTHERS

---

**Base Latency:** Only disable this if you are absolutely sure that your audio system – hardware as well as software – uses buffers that are a multiple of 16 samples. Otherwise you should leave it at the default '16 samples'. This setting only takes effect when the host allows e.g. on playback, after switching sample rates, or after reloading Repro-5. See the information box on the next page "About the Repro-5 Buffers".

**Control A/B Default:** The list of modulation sources in the previous version of Repro included the fixed MIDI control sources Breath (CC#02) and Xpress (expression pedal, CC#11). While retaining backwards compatibility, we replaced them both with the user-definable *Control A* and *Control B* performance sources, with Breath and Expression set as the defaults.

**HQ Default:** Whether *HQ* should be set to *High Quality* for each new instance. *High Quality* is seldom necessary – you can save a significant amount of CPU if you leave this switched off!

**MIDI Control Slew:** Adjusts the amount of ‘smoothing’ for Pitch Bend, Modulation Wheel, Control A, Control B and Aftertouch. While set to *Off*, Repro-5 responds more quickly to modulation wheel (for instance), but might become too grainy for your tastes. The *Fast* setting is a good compromise between response and smoothness.

**Multicore Threads:** Sets the number of threads (instruction streams) this instance of Repro-5 will use while the [MCORE] button is active (see [MCORE button](#)). The operating system is then responsible for how threads are distributed within and/or across the available CPU cores.

The optimum number for minimum CPU load depends on your computer hardware, operating system, host application and how many instances are running in parallel. While using multiple instances of Repro-5 you should generally avoid setting higher values than the default (4).

#### ABOUT THE REPRO-5 BUFFERS

Repro-5 processes audio in chunks of  $n \times 16$  samples. This *block processing* method significantly reduces the CPU load and memory usage of all our plug-ins.

If the number of samples to be processed is e.g. 41, Repro-5 processes the first 32 and keeps the remaining 9 in a small buffer (16 samples is large enough). Those 9 samples are then processed at the start of the next call... and so on.

The extra buffer is only necessary if the host or audio driver processes ‘unusual’ buffer sizes. If your host processes buffers of e.g. 64, 128, 256 or 512 samples (these are all multiples of 16), try setting Base Latency to *off* so that Repro-5 can process latency-free.

## 7 NKS

Repro-5 supports Native Instruments (NI) **NKS extensions** for VST2. All Windows audio plug-in hosts and certain macOS hosts can load VST2.

This means that Repro-5 can be integrated into the **Komplete Kontrol** software or **Maschine** environments: As well as the u-he cross-platform h2p formats, you can also install the factory presets as tagged **.nksf** files. In the VST2 version only, *nksf* also appears in the context menu of the [SAVE] button.

As we wanted to keep them synth-specific, the *Category* options (see [PRESET BROWSER](#)) differ from the Komplete Kontrol / Maschine *Type* tags. During conversion to NKS (see below) Repro-5 automatically converts *Category* tags to the closest corresponding *Type*.

In Komplete Kontrol / Maschine, any untagged presets will appear in *Synth Misc*.

*Presets saved in NKS format do not appear in Repro-5's browser!*

### Saving as nksf

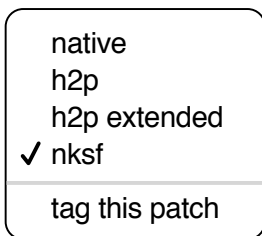

Right-clicking the [SAVE] button opens a small menu offering a choice of several preset formats.

While the *native*, *h2p* and *h2p extended* formats allow Repro-5 to save presets into the currently selected folder, choosing *nksf* causes them to land in a location specified by NI. For more detailed information, please refer to Native Instruments' own NKS documentation.

### Conversion to nksf

Set the format to *nksf* by right-clicking on the [SAVE] button and choosing the *nksf* option. Open Repro-5's browser, select the presets you want to convert, right-click on one of them and choose *convert to nksf*. A text message appears telling you how many were converted and how to update the Komplete Kontrol database. During conversion, a few pages of performance controls mapped to common parameters are generated and saved with each *.nksf* preset.

If you encounter any problems, see the next chapter, Troubleshooting.

## 8 Troubleshooting

### 8-1 NKS

#### Repro-5 doesn't appear in Komplete Kontrol / Maschine

Firstly, make sure that you have Komplete Kontrol Software version 1.5+ or Maschine version 2.4 – the minimum requirements for our implementation of NKS.

Under Windows, Komplete Kontrol needs to register the location of Repro-5's VST2 file: Open the Komplete Kontrol preferences, go to *Locations* and add the directory that contains either Repro-5(x64).dll or Repro-5.dll (as specified during Repro installation). Hit *Rescan* and check whether Repro-5 appears.

If the NKS preset folder is empty you should reinstall Repro with the correct VST path and the NKS-option checked. Here are the preset folder locations:

**Mac** *MacHD/Library/Application Support/u-he/Repro-1/NKS/Repro-5/*

**Win** *C:\Users\\*YOU\*\Documents\u-he\Repro-1.data\NKS\Repro-5\*

Perhaps the XML-File is missing from the following path:

**Mac** *MacHD/Library/Application Support/Native Instruments/Service Center/u-he-Repro-5.xml*

**Win** *C:\Program Files\Common Files\Native Instruments\Service Center\u-he-Repro-5.xml*

A re-install with the NKS-option checked should also resolve this issue.

#### Error message “Could not load plug-in (plug-in not found)”

Repro-5's VST file isn't in the directory specified by the Komplete Kontrol preference. Reason: Either Repro-1 wasn't installed as a VST at all, or it wasn't installed with the correct path. Note that the VST path is fixed in OSX/macOS but is user-definable in Windows:

**Mac** *Macintosh HD/Library/Audio/Plug-Ins/VST/u-he/*

**Win** *<User VST Folder>/* (path for the VST plug-in used during installation)

If the VST plug-in isn't in this directory you will need to reinstall Repro-1 with the VST option checked and the correct VST path.

### 8-2 DC Thump

In certain hosts a Repro-5 track can start with a noticeable DC offset, which fades within about half a second. This effect is typical of analogue circuitry when first switched on, and it therefore also affects component-level models. Seldom noticed in hardware synths as they are not switched off each time a song is stopped, DC thump can become a problem in VA models.

Solution: Start your song with an empty bar or two so that Repro-5 is "switched on" well before the first note in the song arrives. If that doesn't help, it's likely that the host application doesn't process any plugins before the first note is played. In such cases you should try placing a “dummy” note well before the song begins.